

Type 2XS Wi-Fi™ + Bluetooth® Module

NXP 88W9098 Chipset for 802.11a/b/g/n/ac/ax 2x2 MIMO +
Bluetooth 5.3 Datasheet - Rev. 9

- Design Name: Type 2XS
- P/N: LBEE5ZZ2XS-846



Table of Contents

1 Scope	7
2 Key Features	7
3 Ordering Information	7
4 Block Diagram	8
5 Certification Information	10
5.1 Radio Certification.....	10
5.2 Bluetooth Qualification	10
6 Dimensions, Markings and Terminal Configurations	11
7 Module Pin Descriptions	12
7.1 Pin Assignments	12
7.2 Pin Descriptions	14
7.3 Configuration Pins.....	18
7.4 Pin States	18
7.5 SDIO Pin Descriptions	20
8 Absolute Maximum Ratings	21
9 Operating Condition	22
9.1 Operating Condition	22
9.2 Digital I/O Requirements	22
10 Power Sequence	23
10.1 Power-On Sequence.....	23
10.1.1 Power-On Sequence for 3.3V.....	23
10.1.2 Power-On Sequence for 1.8V.....	24
10.2 Power-Off Sequence.....	25
11 Host Interface Specification	26
11.1 SDIO Specifications	26
11.1.1 Default Speed, High Speed Modes.....	26
11.1.2 SDR12, SDR25, SDR50 Modes up to 100 MHz (1.8V).....	27
11.1.3 SDR104 Mode at 208 MHz (1.8V)	28
11.1.4 DDR50 Mode at 50 MHz (1.8V)	29
11.2 PCI Express Specifications	32
11.2.1 Differential Tx Output Electricals.....	32
11.2.2 Differential Rx Input Electricals.....	35
12 DC/RF Characteristics	37
12.1 DC/RF Characteristics for IEEE 802.11b - 2.4 GHz.....	38
12.1.1 High-Rate Condition for IEEE 802.11b - 2.4 GHz	38

12.1.2 Low-Rate Condition for IEEE 802.11b - 2.4 GHz	39
12.2 DC/RF Characteristics for IEEE 802.11g - 2.4 GHz.....	40
12.2.1 High-Rate Condition for IEEE 802.11g - 2.4 GHz	40
12.2.2 Low-Rate Condition for IEEE 802.11g - 2.4 GHz	41
12.3 DC/RF Characteristics for IEEE 802.11n - 2.4 GHz.....	42
12.3.1 High-Rate Condition for IEEE 802.11n - 2.4 GHz	42
12.3.2 Low-Rate Condition for IEEE 802.11n - 2.4 GHz	43
12.4 DC/RF Characteristics for IEEE 802.11ax - 2.4 GHz.....	44
12.4.1 High-Rate Condition for IEEE 802.11ax - 2.4 GHz	44
12.4.2 Low-Rate Condition for IEEE 802.11ax - 2.4 GHz	45
12.5 DC/RF Characteristics for IEEE 802.11a - 5 GHz.....	46
12.5.1 High-Rate Condition for IEEE 802.11a - 5 GHz	46
12.5.2 Low-Rate Condition for IEEE 802.11a - 5 GHz	47
12.6 DC/RF Characteristics for IEEE 802.11n (HT20) - 5 GHz.....	48
12.6.1 High-Rate Condition for IEEE 802.11n (HT20) - 5 GHz	48
12.6.2 Low-Rate Condition for IEEE 802.11n (HT20) - 5 GHz.....	49
12.7 DC/RF Characteristics for IEEE 802.11ac (VHT20) - 5 GHz	50
12.7.1 High-Rate Condition for IEEE 802.11ac (VHT20) - 5 GHz	51
12.7.2 Low-Rate Condition for IEEE 802.11ac (VHT20) - 5 GHz.....	52
12.8 DC/RF Characteristics for IEEE 802.11n (HT40) - 5 GHz.....	53
12.8.1 High-Rate Condition for IEEE 802.11n (HT40) - 5 GHz	53
12.8.2 Low-Rate Condition for IEEE 802.11n (HT40) - 5 GHz.....	54
12.9 DC/RF Characteristics for IEEE 802.11ac (VHT40) - 5 GHz	55
12.9.1 High-Rate Condition for IEEE 802.11ac (VHT40) - 5 GHz	55
12.9.2 Low-Rate Condition for IEEE 802.11ac (VHT40) - 5 GHz.....	56
12.10 DC/RF Characteristics for IEEE 802.11ac (VHT80) - 5 GHz.....	57
12.10.1 High-Rate Condition for IEEE 802.11ac (VHT80) - 5 GHz	57
12.10.2 Low-Rate Condition for IEEE 802.11ac (VHT80) - 5 GHz.....	58
12.11 DC/RF Characteristics for IEEE 802.11ax (HE20) - 5 GHz.....	59
12.11.1 High-Rate Condition for IEEE 802.11ax (HE20) - 5 GHz	60
12.11.2 Low-Rate Condition for IEEE 802.11ax (HE20) - 5 GHz	61
12.12 DC/RF Characteristics for IEEE 802.11ax (HE40) - 5 GHz.....	62
12.12.1 High-Rate Condition for IEEE 802.11ax (HE40) - 5 GHz	62
12.12.2 Low-Rate Condition for IEEE 802.11ax (HE40) - 5 GHz.....	63
12.13 DC/RF Characteristics for IEEE 802.11ax (HE80) - 5 GHz.....	64
12.13.1 High-Rate Condition for IEEE 802.11ax (HE80) - 5 GHz	64
12.13.2 Low-Rate Condition for IEEE 802.11ax (HE80) - 5 GHz	65

12.14 DC/RF Characteristics for Bluetooth.....	66
12.14.1 Basic Data Rate Condition.....	66
12.14.2 Enhanced Data Rate Condition	67
12.15 DC/RF Characteristics for Bluetooth Low Energy	68
12.15.1 1 Mbps PHY Condition	68
12.15.2 2 Mbps PHY Condition	69
13 Land Patterns	71
14 Tape and Reel Packing.....	72
14.1 Dimensions of Tape (Plastic Tape).....	72
14.2 Dimensions of Reel	73
14.3 Taping Diagrams.....	74
14.4 Leader and Tail Tape	75
14.5 Packaging (Humidity Proof Packing)	76
15 Notice	77
15.1 Storage Conditions.....	77
15.2 Handling Conditions	77
15.3 Standard PCB Design (Land Pattern and Dimensions)	77
15.4 Notice for Chip Placer	78
15.5 Soldering Conditions	78
15.6 Cleaning.....	78
15.7 Operational Environment Conditions	79
16 Precondition to Use Our Products.....	80
Revision History.....	82

Figures

Figure 1: Block Diagram	9
Figure 2: Dimensions, Markings and Terminal Configurations	11
Figure 3: Structure	12
Figure 4: Pin Assignments Top View	13
Figure 5: SDIO Modes	20
Figure 6: Power-On Sequence Graph for VIO 3.3V	23
Figure 7: Power-On Sequence Graph for VIO 1.8V	24
Figure 8: Power-Off Sequence Graph.....	25
Figure 9: SDIO Protocol Timing Diagram - Default Speed Mode (3.3V)	26
Figure 10: SDIO Protocol Timing Diagram - High Speed Mode (3.3V)	26
Figure 11: SDIO Protocol Timing Diagram - SDR12, SDR25, SDR50 Modes	27
Figure 12: SDIO Protocol Timing Diagram - SDR104 Mode.....	28

Figure 13: SDIO CMD Timing Diagram - DDR50 Mode	29
Figure 14: SDIO DAT[3:0] Timing Diagram - DDR50 Mode	30
Figure 15: Burst Current Definition.....	37
Figure 16: Land Patterns (Unit: mm)	71
Figure 17: Dimensions of Tape (Plastic Tape)	72
Figure 18: Dimensions of Reel (Unit: mm)	73
Figure 19: Taping Diagrams.....	74
Figure 20: Leader and Tail Tape.....	75
Figure 21: Peeling Force.....	76
Figure 22: Humidity Proof Packing.....	76
Figure 23: Reflow Soldering Standard Conditions (Example).....	78

Tables

Table 1: Document Conventions.....	6
Table 2: Ordering Information	7
Table 3: Radio Certification.....	10
Table 4: Markings	11
Table 5: Dimensions	12
Table 6: Terminal Configurations	13
Table 7: Pin Descriptions	14
Table 8: Configuration Pins.....	18
Table 9: I/O State Table.....	19
Table 10: SDIO Pin Descriptions	20
Table 11: Absolute Maximum Ratings.....	21
Table 12: Operating Conditions	22
Table 13: Digital I/O Requirements Parameters.....	22
Table 14: SDIO Timing Data - Default Speed, High Speed Modes (3.3V).....	27
Table 15: SDIO Timing Data - SDR12, SDR25, SDR50 Modes	28
Table 16: SDIO Timing Data - SDR104 Mode.....	29
Table 17: SDIO Timing Data - DDR50 Mode	30
Table 18: PCI Express Tx Output Specifications Data - 2.5 GT/s.....	32
Table 19: PCI Express Tx Output Specifications Data - 5 GT/s.....	33
Table 20: PCI Express Rx Input Specifications Data - 2.5 GT/s.....	35
Table 21: PCI Express Rx Input Specifications Data - 5 GT/s.....	36
Table 22: DC/RF Characteristic Files.....	37
Table 23: DC/RF Characteristics for IEEE 802.11b - 2.4 GHz.....	38
Table 24: High-Rate Condition for IEEE 802.11b - 2.4 GHz.....	38
Table 25: Low-Rate Condition for IEEE 802.11b - 2.4 GHz.....	39
Table 26: DC/RF Characteristics for IEEE 802.11g - 2.4 GHz.....	40

Table 27: High-Rate Condition for IEEE 802.11g - 2.4 GHz.....	40
Table 28: Low-Rate Condition for IEEE 802.11g - 2.4 GHz.....	41
Table 29: DC/RF Characteristics for IEEE 802.11n - 2.4 GHz.....	42
Table 30: High-Rate Condition for IEEE 802.11n - 2.4 GHz.....	42
Table 31: Low-Rate Condition for IEEE 802.11n - 2.4 GHz.....	43
Table 32: DC/RF Characteristics for IEEE 802.11ax - 2.4 GHz.....	44
Table 33: High-Rate Condition for IEEE 802.11ax - 2.4 GHz.....	44
Table 34: Low-Rate Condition for IEEE 802.11ax - 2.4 GHz.....	45
Table 35: DC/RF Characteristics for IEEE 802.11a - 5 GHz.....	46
Table 36: High-Rate Condition for IEEE 802.11a - 5 GHz.....	46
Table 37: Low-Rate Condition for IEEE 802.11a - 5 GHz.....	47
Table 38: DC/RF Characteristics for IEEE 802.11n (HT20) - 5 GHz.....	48
Table 39: High-Rate Condition for IEEE 802.11n (HT20) - 5 GHz.....	48
Table 40: Low-Rate Condition for IEEE 802.11n (HT20) - 5 GHz.....	49
Table 41: DC/RF Characteristics for IEEE 802.11ac (VHT20) - 5 GHz.....	50
Table 42: High-Rate Condition for IEEE 802.11ac (VHT20) - 5 GHz.....	51
Table 43: Low-Rate Condition for IEEE 802.11ac (VHT20) - 5 GHz.....	52
Table 44: DC/RF Characteristics for IEEE 802.11n (HT40) - 5 GHz.....	53
Table 45: High-Rate Condition for IEEE 802.11n (HT40) - 5 GHz.....	53
Table 46: Low-Rate Condition for IEEE 802.11n (HT40) - 5 GHz.....	54
Table 47: DC/RF Characteristics for IEEE 802.11ac (VHT40) - 5 GHz.....	55
Table 48: High-Rate Condition for IEEE 802.11ac (VHT40) - 5 GHz.....	55
Table 49: Low-Rate Condition for IEEE 802.11ac (VHT40) - 5 GHz.....	56
Table 50: DC/RF Characteristics for IEEE 802.11ac (VHT80) - 5 GHz.....	57
Table 51: High-Rate Condition for IEEE 802.11ac (VHT80) - 5 GHz.....	57
Table 52: Low-Rate Condition for IEEE 802.11ac (VHT80) - 5 GHz.....	58
Table 53: DC/RF Characteristics for IEEE 802.11ax (HE20) - 5 GHz.....	59
Table 54: High-Rate Condition for IEEE 802.11ax (HE20) - 5 GHz.....	60
Table 55: Low-Rate Condition for IEEE 802.11ax (HE20) - 5 GHz.....	61
Table 56: DC/RF Characteristics for IEEE 802.11ax (HE40) - 5 GHz.....	62
Table 57: High-Rate Condition for IEEE 802.11ax (HE40) - 5 GHz.....	62
Table 58: Low-Rate Condition for IEEE 802.11ax (HE40) - 5 GHz.....	63
Table 59: DC/RF Characteristics for IEEE 802.11ax (HE80) - 5 GHz.....	64
Table 60: High-Rate Condition for IEEE 802.11ax (HE80) - 5 GHz.....	64
Table 61: Low-Rate Condition for IEEE 802.11ax (HE80) - 5 GHz.....	65
Table 62: Basic Data Rate Condition.....	66
Table 63: Enhanced Data Rate Condition.....	67
Table 64: 1 Mbps PHY Condition.....	68
Table 65: 2 Mbps PHY Condition.....	69
Table 66: Taping Specifications.....	74

About This Document

Murata's Type 2XS is a small and very high-performance module based on NXP 88W9098 combo chipset, supporting IEEE 802.11a/b/g/n/ac/ax 2x2 MIMO + Bluetooth 5.3 BR/EDR/LE. This datasheet describes Type 2XS module in detail.



Please be aware that an important notice concerning availability, standard warranty and use in critical applications of Murata products and disclaimers thereto appears at the end of this specification sheet.









Audience & Purpose

Intended audience includes any customer looking to integrate this module into their product. In particular, RF, hardware, software, and systems engineers.

Document Conventions

Table 1 describes the document conventions.

Table 1: Document Conventions

Conventions	Description
	Warning Note Indicates very important note. Users are strongly recommended to review.
	Info Note Intended for informational purposes. Users should review.
	Menu Reference Indicates menu navigation instructions. Example: Insert → Tables → Quick Tables → Save Selection to Gallery 
	External Hyperlink This symbol indicates a hyperlink to an external document or website. Example: Murata Manufacturing Co., Ltd.  Click on the text to open the external link.
	Internal Hyperlink This symbol indicates a hyperlink within the document. Example: Scope  Click on the text to open the link.
<code>Console input/output or code snippet</code>	Console I/O or Code Snippet This text Style denotes console input/output or a code snippet.
<code># Console I/O comment // Code snippet comment</code>	Console I/O or Code Snippet Comment This text Style denotes a console input/output or code snippet comment. <ul style="list-style-type: none"> • Console I/O comment (preceded by "#") is for informational purposes only and does not denote actual console input/output. • Code Snippet comment (preceded by "//") may exist in the original code.

1 Scope

This specification characterizes the IEEE 802.11 a/b/g/n/ac/ax 2x2 MIMO + Bluetooth 5.3 combo BR/EDR/LE module.

2 Key Features

- ◆ NXP 88W9098 inside
- ◆ Supports IEEE 802.11a/b/g/n/ac/ax specification: Dual band 2.4 GHz and 5 GHz
- ◆ MIMO with 20 MHz, 40 MHz and 80 MHz channels
- ◆ Up to MCS11 data rates (1200 Mbps)
- ◆ Supports Bluetooth specification version 5.3
- ◆ For supported Bluetooth functions, refer to [Bluetooth SIG site](#) 
- ◆ WLAN interface: PCIe 2.0 and SDIO 3.0
- ◆ Bluetooth interface: HCI UART and PCM
- ◆ Dimensions: 19.1 x 16.5 x 2.1 mm
- ◆ Weight: 1355 mg
- ◆ MSL: 3
- ◆ Surface-mount type
- ◆ RoHS compliant
- ◆ B10 life: 13 years, B1 life: 10 years
(Wear-out failure with 20°C daily ambient room temperature change)
- ◆ Fit: 140.36 (Accidental failure)

3 Ordering Information

Table 2 describes the ordering information for Type 2XS module.

Table 2: Ordering Information

Ordering Part Number	Description
LBEE5ZZ2XS-846	Module order
LBEE5ZZ2XS-SMP	Sample module order (If module samples are not available through distribution, contact Murata referencing this part number)
EAR00411	Embedded Artists Type 2XS M.2 EVB (default EVB available through distribution)

4 Block Diagram

The Type 2XS block diagram is presented in **Figure 1: Block Diagram**

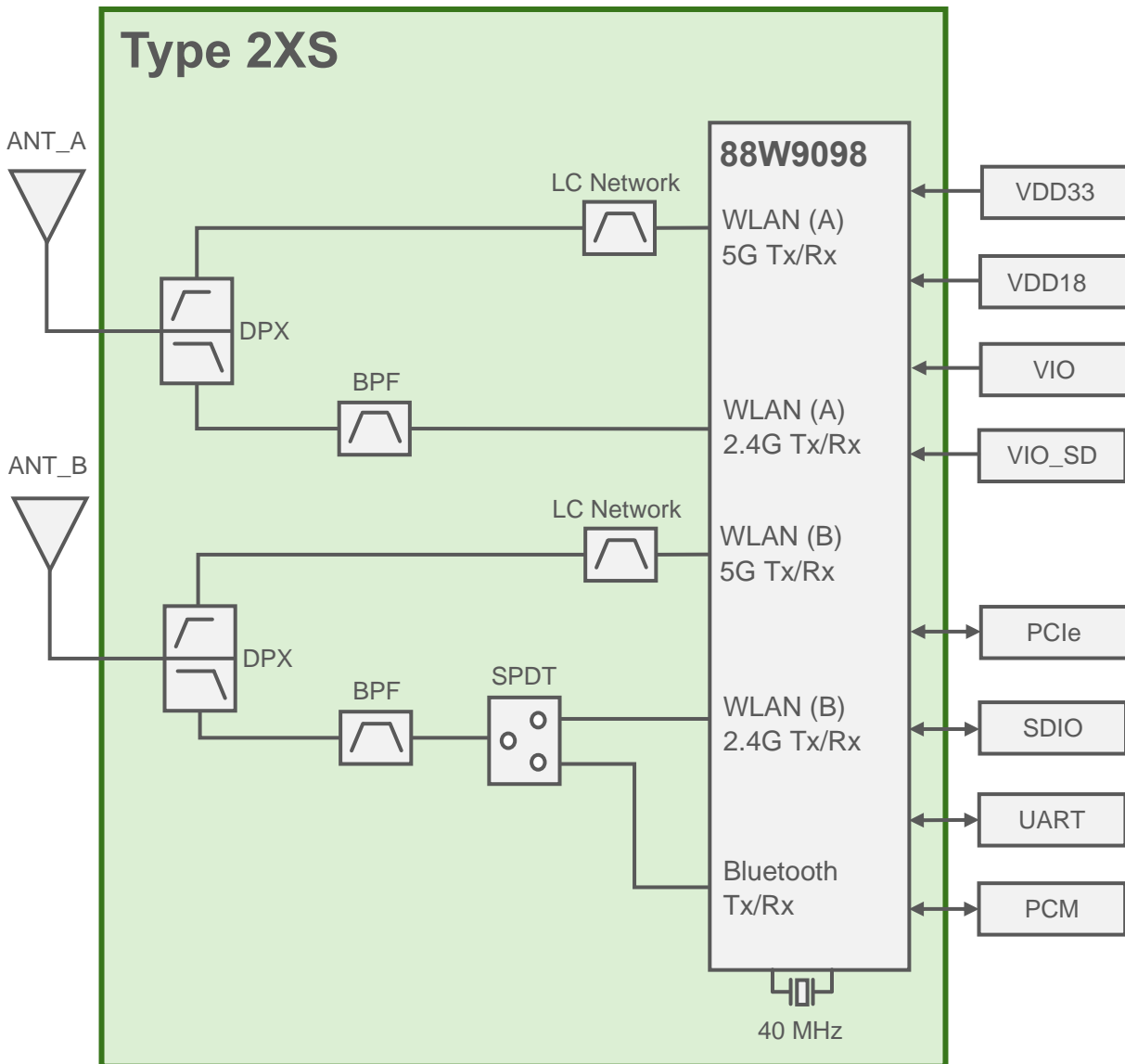
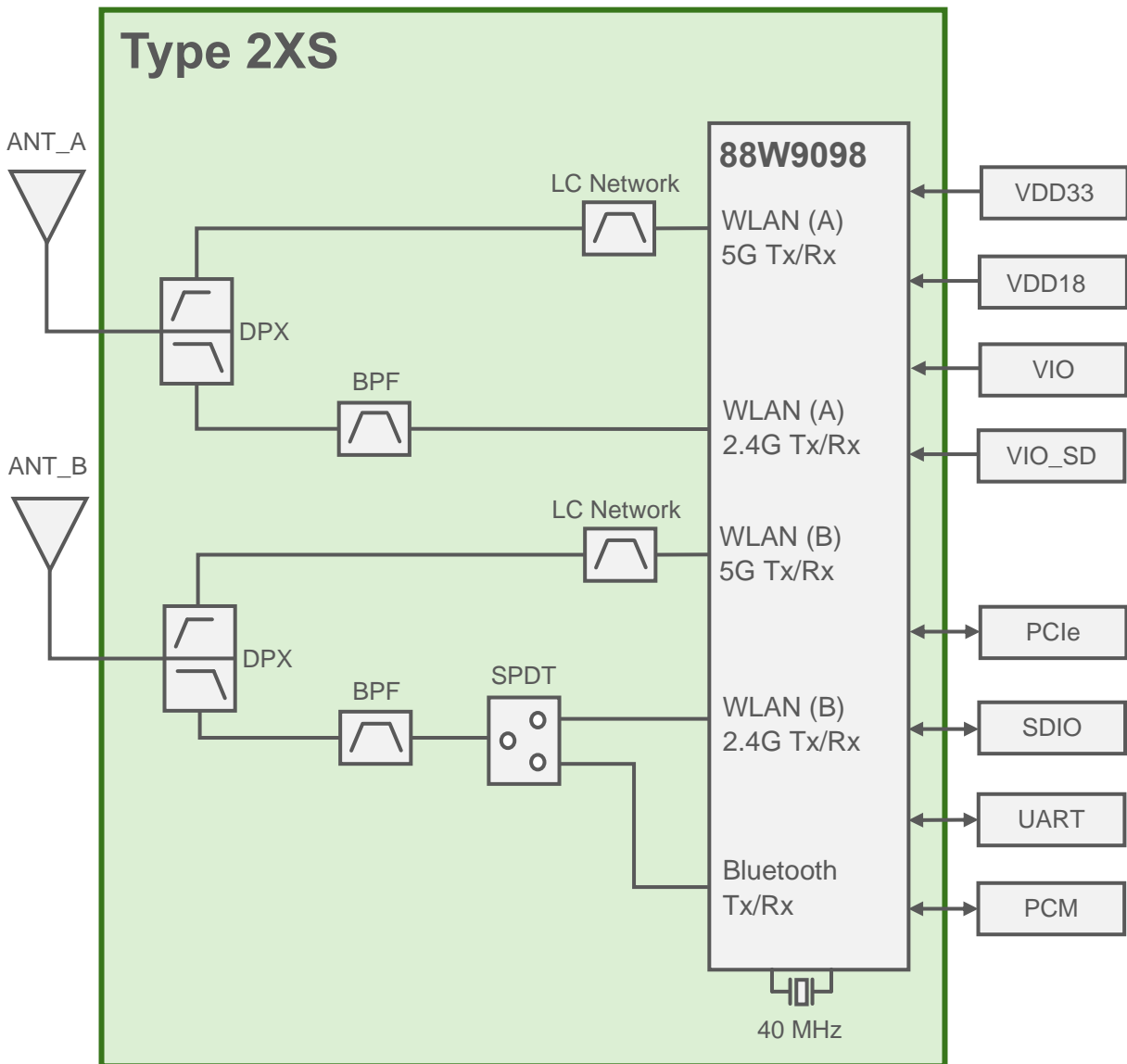

Figure 1: Block Diagram



5 Certification Information

This section has information about radio and Bluetooth certification.

5.1 Radio Certification

Table 3 shows the radio certification information.



Table 3: Radio Certification

Country	ID	Country Code
USA (FCC)	VPYLBEE5ZZ1XL	US
Canada (IC)	772C-LBEE5ZZ1XL	CA
Europe	EN300328/301893, EN300440 conducted test report is prepared.	DE
Japan	Japanese type certification is prepared.  001-P01770	JP



Each country code is defined by Murata's DB.txt file. Please ask your contact person from Murata.

5.2 Bluetooth Qualification

- DIN/DN: D058811, QDID/Included DN: 184816
- Set Bluetooth Tx Power to Class 1 by using [bt_power_config_1.sh](#) .
- For supported Bluetooth functions, refer to [Bluetooth SIG site](#) .

6 Dimensions, Markings and Terminal Configurations

This section provides information about dimensions, markings, and terminal configuration for Type 2XS and the related parameters. **Figure 2** shows the dimensions, markings, and terminal configurations.

Figure 2: Dimensions, Markings and Terminal Configurations

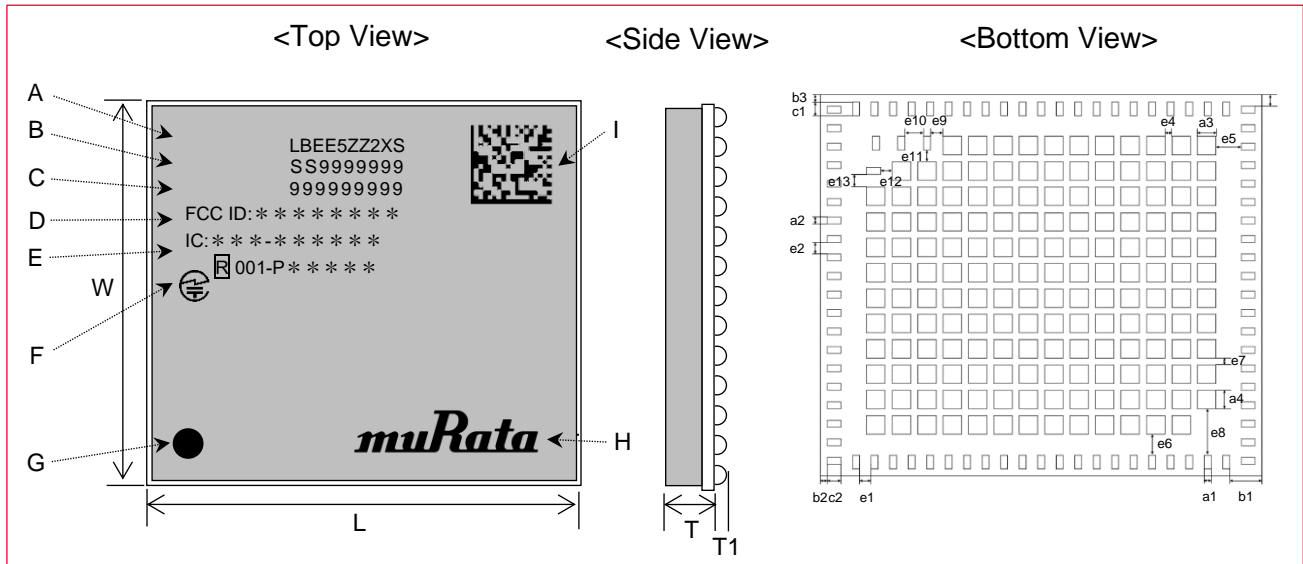

Table 4 describes the Type 2XS markings.

Table 4: Markings

Marking	Meaning
A	Module Type
B	Production Process Number
C	Serial Number
D	FCC ID
E	ISED ID
F	Japan certification mark & ID
G	Pin-1 Marking
H	Murata Logo
I	2D code

Table 5 describes the Type 2XS dimensions.

Table 5: Dimensions

Mark	Dimensions (mm)	Mark	Dimensions (mm)	Mark	Dimensions (mm)
L	19.1 +/- 0.2	W	16.5 +/- 0.2	T	2.1 maximum
T1	0.45 typical	a1	0.3 +/- 0.1	a2	0.3 +/- 0.1
a3	0.8 +/- 0.1	a4	0.8 +/- 0.1	b1	1.4 +/- 0.2
b2	0.3 +/- 0.2	b3	0.3 +/- 0.2	c1	0.6 +/- 0.1
c2	0.6 +/- 0.1	e1	0.5 +/- 0.1	e2	0.5 +/- 0.1
e3	0.5 +/- 0.2	e4	0.3 +/- 0.1	e5	1.1 +/- 0.1
e6	0.9 +/- 0.1	e7	0.3 +/- 0.1	e8	2.0 +/- 0.1
e9	0.55 +/- 0.1	e10	0.8 +/- 0.1	e11	0.5 +/- 0.1
e12	0.5 +/- 0.1	e13	0.55 +/- 0.1		

The structure of Type 2XS is as shown in **Figure 3**.

Figure 3: Structure

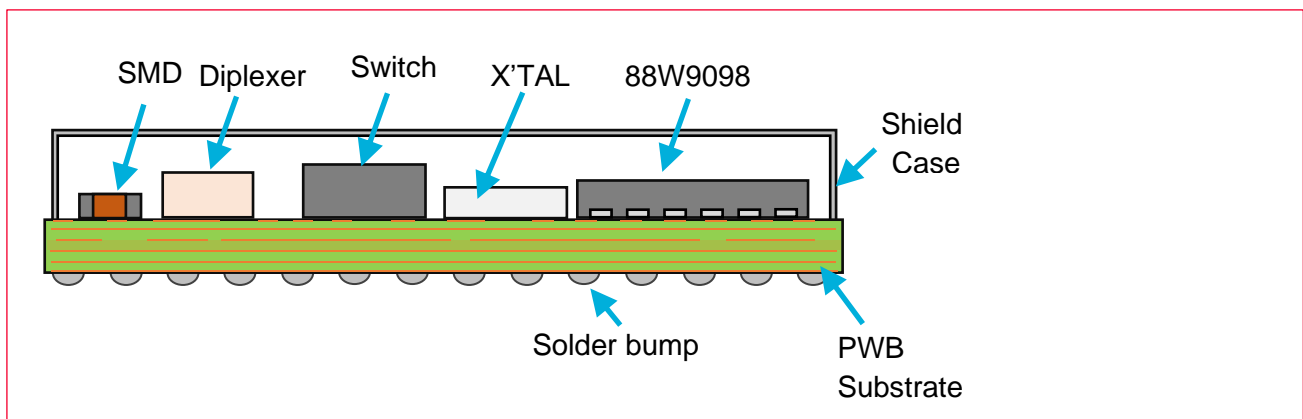

7 Module Pin Descriptions

This section has the pin descriptions of Type 2XS and pin assignments layout descriptions.

7.1 Pin Assignments

This section describes the pin assignments to terminals. Type 2XS pin-assignment top view is presented in **Figure 4**.

Figure 4: Pin Assignments Top View

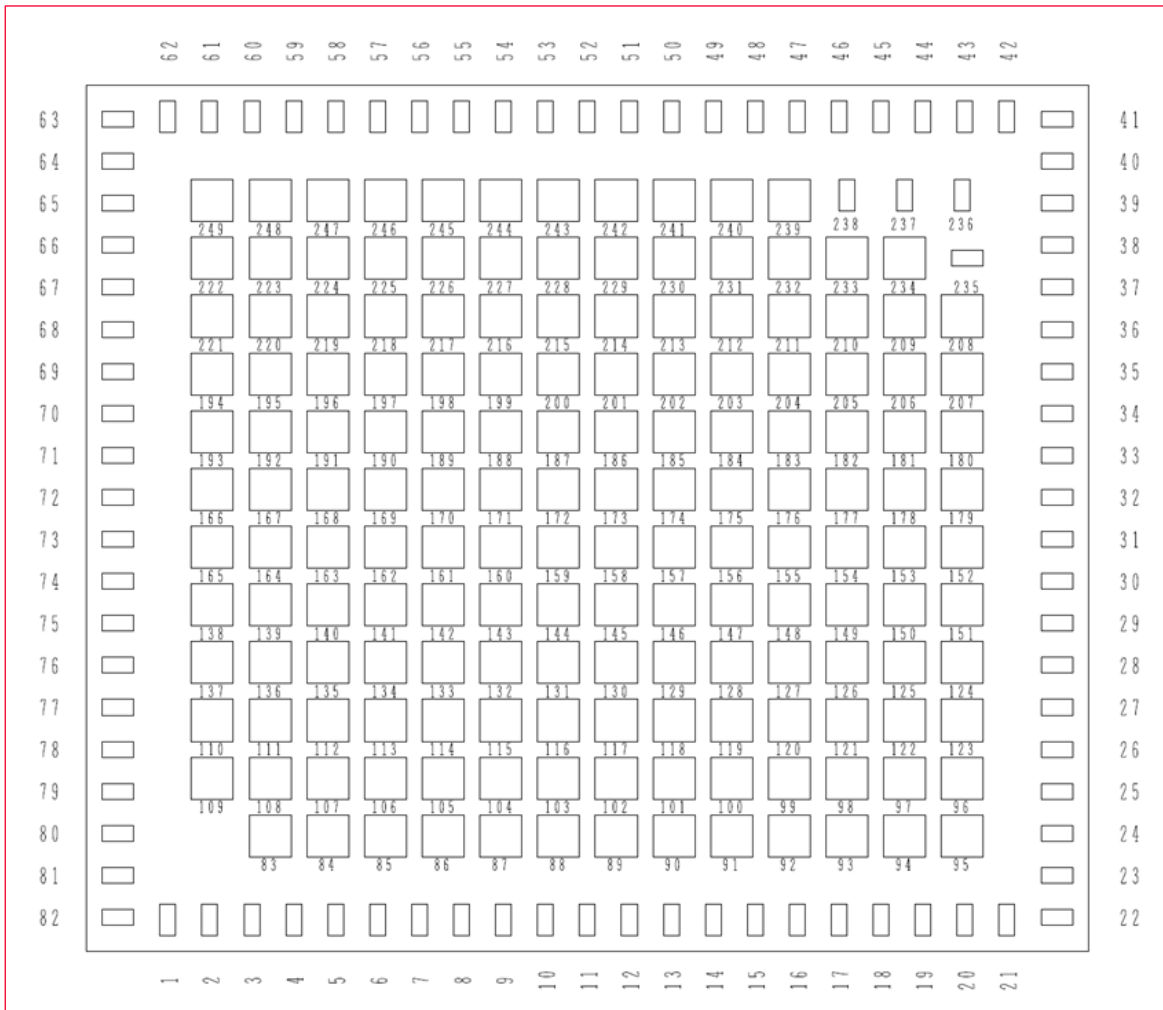

Table 6 lists the Type 2XS terminal configurations.

Table 6: Terminal Configurations

No.	Terminal Name	No.	Terminal Name	No.	Terminal Name
1	GND	31	GND	61	GPIO[26]
2	GND	32	NC	62	GPIO[27]
3	CONFIG_HOST[0]	33	NC	63	GND
4	CONFIG_HOST[1]	34	GND	64	GND
5	CONFIG_HOST[2]	35	VIO_SD	65	BT_RF_OUT
6	GPIO[1]	36	SD_CLK	66	GND
7	GPIO[0]	37	SD_CMD	67	GND
8	GPIO[14]	38	SD_D[0]	68	NC
9	GPIO[4]	39	SD_D[1]	69	GND
10	GPIO[6]	40	SD_D[2]	70	GPIO[22]
11	GPIO[5]	41	GND	71	GPIO[23]
12	GPIO[7]	42	SD_D[3]	72	GPIO[19]

No.	Terminal Name	No.	Terminal Name	No.	Terminal Name
13	GPIO[16]	43	PCIE_PERSTn	73	GPIO[18]
14	GPIO[15]	44	PCIE_CLKREQn	74	GPIO[17]
15	PDn	45	PCIE_WAKEn	75	GND
16	GND	46	W_DISABLE1n	76	WL_B_ANT/ WL_B_BT_ANT
17	VDD33	47	GPIO[31]	77	GND
18	VDD33	48	GPIO[29]	78	GND
19	VIO	49	GPIO[30]	79	GND
20	VDD18	50	GPIO[28]	80	WL_A_ANT
21	VDD18	51	GPIO[3]	81	GND
22	GND	52	GPIO[2]	82	GND
23	PCIE_CLK_N	53	GPIO[11]	83-234	GND
24	PCIE_CLK_P	54	GPIO[10]	235	RF_CNTL0_N
25	GND	55	GPIO[9]	236	RF_CNTL3_P
26	PCIE_TX_P	56	GPIO[8]	237	RF_CNTL2_N
27	PCIE_TX_N	57	GPIO[12]	238	RF_CNTL1_P
28	GND	58	GPIO[13]	239- 248	GND
29	PCIE_RX_N	59	GPIO[24]	249	NC
30	PCIE_RX_P	60	GPIO[25]		

7.2 Pin Descriptions

Table 7 has the pin descriptions.

Table 7: Pin Descriptions

No.	Terminal Name	Type	Power Supply	Description
1	GND	GND		Ground
2	GND	GND		Ground
3	CONFIG_HOST[0]	I	VDD18	Host configuration options. Selects the host interface used for Wi-Fi and Bluetooth. See Section 7.3 . Internal pull-up
4	CONFIG_HOST[1]	I	VDD18	Host configuration options. Selects the host interface used for Wi-Fi and Bluetooth. See Section 7.3 . Internal pull-up
5	CONFIG_HOST[2]	I	VDD18	Host configuration options. Selects the host interface used for Wi-Fi and Bluetooth. See Section 7.3 . Internal pull-up
6	GPIO[1]	I/O	VIO	GPIO[1]
7	GPIO[0]	I/O	VIO	GPIO[0]

No.	Terminal Name	Type	Power Supply	Description
8	GPIO[14]	I/O	VIO	CONFIG_AUTO_REF_DET GPIO[14] Keep low level until finished power up sequence.
9	GPIO[4]	I/O	VIO	PCM Mode: Receive PCM input. I2S Mode: Receive I2S input. GPIO[4]
10	GPIO[6]	I/O	VIO	PCM Mode: PCM clock I2S Mode: I2S bit clock. <ul style="list-style-type: none"> • Output if master • Input if slave GPIO[6]
11	GPIO[5]	I/O	VIO	PCM Mode: Transmit PCM output. I2S Mode: Transmit I2S output. GPIO[5]
12	GPIO[7]	I/O	VIO	PCM Mode: PCM frame sync. I2S Mode: I2S left-right clock. <ul style="list-style-type: none"> • Output if master • Input if slave GPIO[7]
13	GPIO[16]	I/O	VIO	GPIO[16] Keep open or input level high until finished power up sequence.
14	GPIO[15]	I/O	VIO	GPIO[15] Keep open or input level high until finished power up sequence.
15	PDn	I	VDD18	Full power-down (input) (active low) <ul style="list-style-type: none"> • 0 = full power-down mode • 1 = normal operation mode • PDn can accept an input of 1.8V to 4.5V • PDn may be driven by the host • PDn must be high for normal operation No internal pull-up on this pin. Connect to power down pin (GPIO) of host or tie to power rail. External host required to drive this pin high for normal operation mode.
16	GND	GND		Ground
17	VDD33	P		3.3V Voltage Input
18	VDD33	P		3.3V Voltage Input
19	VIO	P		1.8V/3.3V Digital I/O Power Supply
20	VDD18	P		1.8V Voltage Input
21	VDD18	P		1.8V Voltage Input
22	GND	GND		Ground
23	PCIE_CLK_N	I	VDD18	PCI Express Differential Clock Input—Negative
24	PCIE_CLK_P	I	VDD18	PCI Express Differential Clock Input—Positive
25	GND	GND		Ground
26	PCIE_TX_P	O	VDD18	PCI Express Transmit Data—Positive
27	PCIE_TX_N	O	VDD18	PCI Express Transmit Data—Negative
28	GND	GND		Ground
29	PCIE_RX_N	I	VDD18	PCI Express Receive Data—Negative

No.	Terminal Name	Type	Power Supply	Description
30	PCIE_RX_P	I	VDD18	PCI Express Receive Data—Positive
31	GND	GND		Ground
32	NC			No Connection
33	NC			No Connection
34	GND	GND		Ground
35	VIO_SD	P		1.8V/3.3V Digital I/O SDIO power supply <ul style="list-style-type: none"> For SDIO ultra-high-speed mode (25 to 208 MHz), VIO_SD must be 1.8V. For SDIO default mode (up to 25 MHz) and high-speed mode (up to 50 MHz), VIO_SD must be 1.8V or 3.3V. Need to be applied even in PCIE mode.
36	SD_CLK	I	VIO_SD	SDIO 4-bit Mode: Clock inputInternal pull-up
37	SD_CMD	I/O	VIO_SD	SDIO 4-bit Mode: Command/response (input/output)Internal pull-up
38	SD_D[0]	I/O	VIO_SD	SDIO 4-bit Mode: Data line Bit[0]Internal pull-up
39	SD_D[1]	I/O	VIO_SD	SDIO 4-bit Mode: Data line Bit[1]Internal pull-up
40	SD_D[2]	I/O	VIO_SD	SDIO 4-bit Mode: Data line Bit[2] or read wait (optional)Internal pull-up
41	GND	GND		Ground
42	SD_D[3]	I/O	VIO_SD	SDIO 4-bit Mode: Data line Bit[3]Internal pull-up
43	PCIE_PERSTn	I	VIO	PCIe host indication to reset the device (input)(active low) Note: Muxed with GPIO[20].(input/output) Internal pull-up
44	PCIE_CLKREQn	O	Open drain	PCIe clock request (input/output) (active low) Note: An external pull-up (on host side) is required. If this pin used as input signal, Power supply is VIO.
45	PCIE_WAKEn	O	Open drain	PCIe wake signal (input/output) (active low) Note: An external pull-up (on host side) is required. If this pin used as input signal, Power supply is VIO.
46	W_DISABLE1n	I	VIO	GPIO Mode: GPIO[21] (input/output) Default Mode: W_DISABLE1n (input) (active low) Host indication to disable the Wi-Fi function of the device. See GPIO[12] for W_DISABLE2n (input) (active low).
47	GPIO[31]	I/O	VIO	GPIO Mode: GPIO[31] (input/output) JTAG Mode: JTAG_TDO, JTAG test data (output) Coexistence Mode: UART_LTE_SOUT (LTE coexistence data output signal)
48	GPIO[29]	I/O	VIO	GPIO Mode: GPIO[29] (input/output) JTAG Mode: JTAG_TMS, JTAG controller select (input)
49	GPIO[30]	I/O	VIO	GPIO Mode: GPIO[30] (input/output) JTAG Mode: JTAG_TDI, JTAG test data (input) Coexistence Mode: UART_LTE_SIN (LTE coexistence data input signal)
50	GPIO[28]	I/O	VIO	GPIO Mode: GPIO[28] (input/output) JTAG Mode: JTAG_TCK, JTAG test clock (input)
51	GPIO[3]	I/O	VIO	GPIO Mode: GPIO[3] (input/output) LED Mode: LED_OUT_BT (output) I2S Mode: I2S_CCLK (output, optional) PCM Mode: PCM_MCLK (output, optional)
52	GPIO[2]	I/O	VIO	GPIO Mode: GPIO[2] (input/output)

No.	Terminal Name	Type	Power Supply	Description
				LED Mode: LED_OUT_WLAN (output)
53	GPIO[11]	I/O	VIO	GPIO Mode: GPIO[11] (input/output) UART Mode: UART_RTSn (output) (active low)
54	GPIO[10]	I/O	VIO	GPIO Mode: GPIO[10] (input/output) UART Mode: UART_CTSn (input) (active low)
55	GPIO[9]	I/O	VIO	GPIO Mode: GPIO[9] (input/output) UART Mode: UART_SIN (input)
56	GPIO[8]	I/O	VIO	GPIO Mode: GPIO[8] (input/output) UART Mode: UART_SOUT (output)
57	GPIO[12]	I/O	VIO	GPIO Mode: GPIO[12] (input/output) Default Mode: W_DISABLE2n (input) (active low) Host indication to disable the Wi-Fi function of the device. See GPIO[21] for W_DISABLE1n (input) (active low).
58	GPIO[13]	I/O	VIO	GPIO Mode: GPIO[13] (input/output)
59	GPIO[24]	I/O	VIO	GPIO Mode: GPIO[24] (input/output)
60	GPIO[25]	I/O	VIO	GPIO Mode: GPIO[25] (input/output)
61	GPIO[26]	I/O	VIO	GPIO Mode: GPIO[26] (input/output)
62	GPIO[27]	I/O	VIO	GPIO Mode: GPIO[27] (input/output)
63	GND	GND		Ground
64	GND	GND		Ground
65	NC	NC		NC
66	GND	GND		Ground
67	GND	GND		Ground
68	NC	NC		NC
69	GND	GND		Ground
70	GPIO[22]	I/O	VDD33	GPIO[22]
71	GPIO[23]	I/O	VDD33	GPIO[23]
72	GPIO[19]	I/O	VIO	GPIO[19]
73	GPIO[18]	I/O	VIO	GPIO[18]
74	GPIO[17]	I/O	VIO	GPIO[17]
75	GND	GND	-	Ground
76	WL_B_BT_ANT	RF		WLAN Transmit/Receive - Path B + Bluetooth Transmit/Receive
77	GND	GND		Ground
78	GND	GND		Ground
79	GND	GND		Ground
80	WL_A_ANT	RF		WLAN Transmit/Receive - Path A
81	GND	GND		Ground
82	GND	GND		Ground
83-234	GND	GND		Ground
235	RF_CNTL0_N	O	VDD33	RF Control 0-RF Control Output Low (output)

No.	Terminal Name	Type	Power Supply	Description
236	RF_CNTL3_P	O	VDD33	RF Control 3-RF Control Output High (output)
237	RF_CNTL2_N	O	VDD33	RF Control 2-RF Control Output Low (output)
238	RF_CNTL1_P	O	VDD33	RF Control 1-RF Control Output High (output)
239-248	GND	GND		Ground
249	NC	GND		No Connection

7.3 Configuration Pins

Table 8 describes the configuration pins.

Table 8: Configuration Pins

Pin Name	Configuration Function
GPIO[6]	Reserved.
GPIO[5]	Reserved.
GPIO[4]	Reserved.
GPIO[17]	Reserved.
GPIO[16]	0
GPIO[15]	0
GPIO[14]	Reserved.
CONFIG_HOST[2:0]	[2:0] 000 = WLAN SDIO, Bluetooth UART [2:0] 011 = WLAN PCIe, Bluetooth UART



Keep logic level until finished power-up sequence.

To set a configuration bit to 0, attach a 51 kΩ resistor from the pin to ground. No external circuitry is required to set a configuration bit to 1. GPIO[4][5][6][14][15][16][17] can be open because these signals have weak or nominal PD on the module or reserve pins. See [Section 7.4](#).

7.4 Pin States

Pin states information for the tables below include:

- After firmware is downloaded, the pads (GPIO, Serial interface, RF control) are programmed in functional mode per the functionality of the pins.
- For SDIO, once the command is received from the host, the pads are configured accordingly.
- Pull-up and pull-down are only effective when the pad is in input mode.
- The power-down state shown is the default configuration. Many pads have programmable power-down values, which can be set by firmware.
- Do not need any termination to the open pins in input mode that have an Internal pull-up/pull-down resistor (PU/PD). Do not need any termination to the open pins in output mode. Do not need any termination to PCIE signals in SDIO mode.

Table 9: I/O State Table

Pin Name	Supply	No Pad Power State ¹	Reset State	HW State	PD State	PD Prog	Internal PU/PD	Int'l Pull Value [Ω]
GPIO[0]	VIO	tristate	output	output	drive low	yes	nominal PU	100K
GPIO[1]	VIO	tristate	input	input	tristate	yes	weak PU	800K
GPIO[2]	VIO	tristate	input	input	tristate	yes	nominal PU	100K
GPIO[3]	VIO	tristate	input	input	tristate	yes	nominal PU	100K
GPIO[4]	VIO	tristate	input	input	tristate	yes	weak PU	800K
GPIO[5]	VIO	tristate	input	input	tristate	yes	weak PU	800K
GPIO[6]	VIO	tristate	input	input	tristate	yes	weak PU	800K
GPIO[7]	VIO	tristate	input	input	tristate	yes	nominal PU	100K
GPIO[8]	VIO	tristate	input	input	drive low	yes	nominal PU	100K
GPIO[9]	VIO	tristate	input	input	tristate	yes	nominal PU	100K
GPIO[10]	VIO	tristate	input	input	tristate	yes	nominal PU	100K
GPIO[11]	VIO	tristate	input	input	drive high	yes	nominal PU	100K
GPIO[12]	VIO	tristate	input	input	tristate	yes	nominal PD	100K
GPIO[13]	VIO	tristate	input	input	drive high	yes	nominal PU	100K
GPIO[14]	VIO	tristate	input	input	tristate	yes	nominal PD on the module	51K
GPIO[15]	VIO	tristate	input	input	tristate	yes	weak PU	800K
GPIO[16]	VIO	tristate	input	input	tristate	yes	weak PU	800K
GPIO[17]	VIO	tristate	input	input	tristate	yes	weak PU	800K
GPIO[18]	VIO	tristate	input	input	tristate	yes	weak PD	800K
GPIO[19]	VIO	tristate	input	input	tristate	yes	weak PU	800K
GPIO[20]	VIO	tristate	input	input	drive high	yes	nominal PU	100K
GPIO[21]	VIO	tristate	input	input	tristate	yes	nominal PU	100K
GPIO[22]	VDD33	tristate	input	input	drive high	yes	weak PU	800K
GPIO[23]	VDD33	tristate	input	input	drive low	yes	weak PU	800K
GPIO[24]	VIO	tristate	input	input	tristate	yes	nominal PU	100K
GPIO[25]	VIO	tristate	input	input	drive high	yes	nominal PU	100K
GPIO[26]	VIO	tristate	input	input	tristate	yes	nominal PU	100K
GPIO[27]	VIO	tristate	input	input	tristate	yes	nominal PU	100K
GPIO[28]	VIO	tristate	input	input	tristate	yes	nominal PU	100K
GPIO[29]	VIO	tristate	input	input	tristate	yes	nominal PD	100K
GPIO[30]	VIO	tristate	input	input	tristate	yes	nominal PU	100K
GPIO[31]	VIO	tristate	input	input	tristate	yes	nominal PU	100K
SD_CLK	VIO	tristate	input	input	tristate	no	nominal PU	100K
SD_CMD	VIO	tristate	input	input	tristate	no	nominal PU	100K
SD_D[0]	VIO	tristate	input	input	tristate	no	nominal PU	100K
SD_D[1]	VIO	tristate	input	input	tristate	no	nominal PU	100K
SD_D[2]	VIO	tristate	input	input	tristate	no	nominal PU	100K
SD_D[3]	VIO	tristate	input	input	tristate	no	nominal PU	100K
PCIE_CLKP	AVDD18	—	—	—	—	—	—	—
PCIE_CLKN	AVDD18	—	—	—	—	—	—	—
PCIE_TXP	AVDD18	—	—	—	—	—	—	—

¹ Maximum input voltage is 0.4V when VIO has no power (or in uncertain situations)

Pin Name	Supply	No Pad Power State ¹	Reset State	HW State	PD State	PD Prog	Internal PU/PD	Int'l Pull Value [Ω]
PCIE_TXN	AVDD18	—	—	—	—	—	—	—
PCIE_RXP	AVDD18	—	—	—	—	—	—	—
PCIE_RXN	AVDD18	—	—	—	—	—	—	—
PCIE_WAKE_N	VIO	tristate	input	output	n/a	n/a	n/a	—
PCIE_CLKREQ_N	VIO	tristate	input	output	n/a	n/a	n/a	—
PCIE_PERST_N	VIO	tristate	input	input	drive high	yes	nominal PU	100K
CONFIG_HOST[0]	AVDD18	tristate	input	input	tristate	no	weak PU	800K
CONFIG_HOST[1]	AVDD18	tristate	input	input	tristate	no	weak PU	800K
CONFIG_HOST[2]	AVDD18	tristate	input	input	tristate	no	weak PU	800K
RF_CNTL0_N	VDD33	tristate	input	output	drive low	yes	nominal PU	100K
RF_CNTL1_P	VDD33	tristate	input	output	drive low	yes	weak PU	800K
RF_CNTL2_N	VDD33	tristate	input	output	drive low	yes	weak PU	800K
RF_CNTL3_P	VDD33	tristate	input	output	drive low	yes	weak PU	800K
PDn	AVDD18	—	—	—	—	—	—	—

7.5 SDIO Pin Descriptions

Table 10 shows the SDIO pin descriptions. **Figure 5** shows the SDIO modes.

Table 10: SDIO Pin Descriptions

No.	Pin Name	(i) SD 4-bit Mode	
55	SD_CLK	CLK	Clock
59	SD_D[0]	DATA0	Data line 0
61	SD_D[1]	DATA1	Data line 1 /Interrupt
63	SD_D[2]	DATA2	Data line 2
65	SD_D[3]	DATA3	Data line 3
57	SD_CMD	CMD	Command line

Figure 5: SDIO Modes

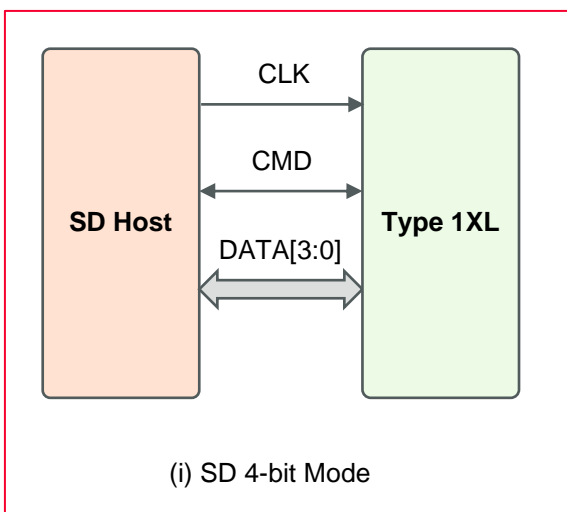

8 Absolute Maximum Ratings

Table 11 describes the absolute maximum ratings.

Table 11: Absolute Maximum Ratings

Parameter	Minimum	Maximum	Unit
Storage Temperature	-40	+85	°C
Supply Voltage	VDD33	3.63	V
	VDD18	2.16	V
	VIO (1.8V)	1.98	V
	VIO (3.3V)	3.63	V
	VIO_SD (1.8V)	1.98	V
	VIO_SD (3.3V)	3.63	V



Stresses in excess of the absolute ratings may cause permanent damage. Functional operation is not implied under these conditions. Exposure to absolute ratings for extended periods of time may adversely affect reliability. No damage assuming only one parameter is set at limit at a time with all other parameters are set within operating condition.

9 Operating Condition

9.1 Operating Condition

Type 2XS operating conditions are described in **Table 12**.

Table 12: Operating Conditions

Parameter		Minimum	Typical	Maximum	Unit	
Operating Temperature Range ²	Ta	-40	+25	+60	°C	
	Tc	-40	+25	+85	°C	
Supply Voltage	VDD33	3.14	3.3	3.46	V	
	VDD18	1.71	1.8	1.89	V	
	VIO		1.71	1.8	1.89	V
			3.14	3.3	3.46	V
	VIO_SD		1.71	1.8	1.89	V
			3.14	3.3	3.46	V
IO Current	VIO & VIO_SD		0.1	0.5	mA	
Peak current	VDD33		1150	1200	mA	
	VDD18		1873	2000	mA	



Operation beyond the recommended operating conditions is neither recommended nor guaranteed. Peak current of VDD33 and VDD18 happen during DPD calibration when the firmware is downloaded.

9.2 Digital I/O Requirements

The digital I/O requirements are listed in **Table 13**.

Table 13: Digital I/O Requirements Parameters

Symbol	Parameter	Condition	Minimum	Typical	Maximum	Unit
V _{IH}	Input high voltage		0.7 * VIO		VIO + 0.4	V
V _{IL}	Input low voltage		-0.4		0.3 * VIO	V
V _{HYS}	Input hysteresis		100			mV
V _{OH}	Output high voltage		VIO - 0.4			V
V _{OL}	Output low voltage		-		0.4	V

² Functionality is guaranteed but specifications require derating at extreme temperatures

10 Power Sequence

This section describes the power-on and power-off sequences.

10.1 Power-On Sequence

10.1.1 Power-On Sequence for 3.3V

- Ramp-up time of VIO must be < 100 ms.
- Ramp-up time of VDD33 must be < 100 ms.
- Ramp-up time of VDD18 must be < 100 ms.

Figure 6 shows the power-on sequence for VIO 3.3V.

Figure 6: Power-On Sequence Graph for VIO 3.3V

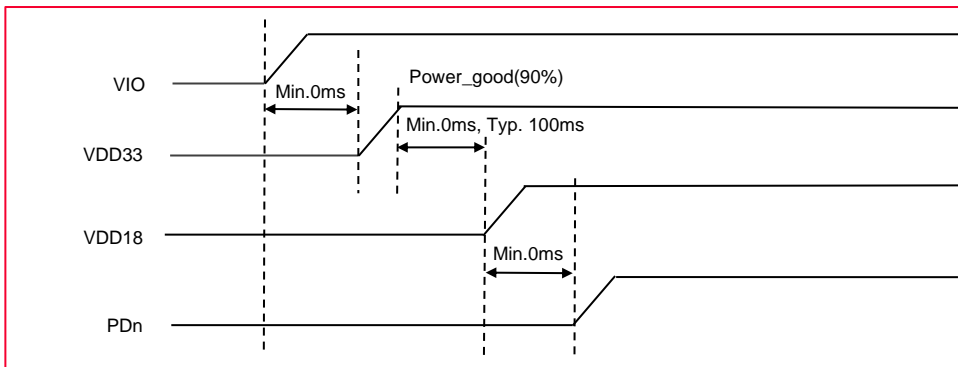

VIO_SD should be ramp-up before PDn assertion.

10.1.2 Power-On Sequence for 1.8V

- Ramp-up time of VIO must be < 100 ms.
- Ramp-up time of VDD33 must be < 100 ms.
- Ramp-up time of VDD18 must be < 100 ms.

Figure 7 shows the power-on sequence for VIO 1.8V.

Figure 7: Power-On Sequence Graph for VIO 1.8V

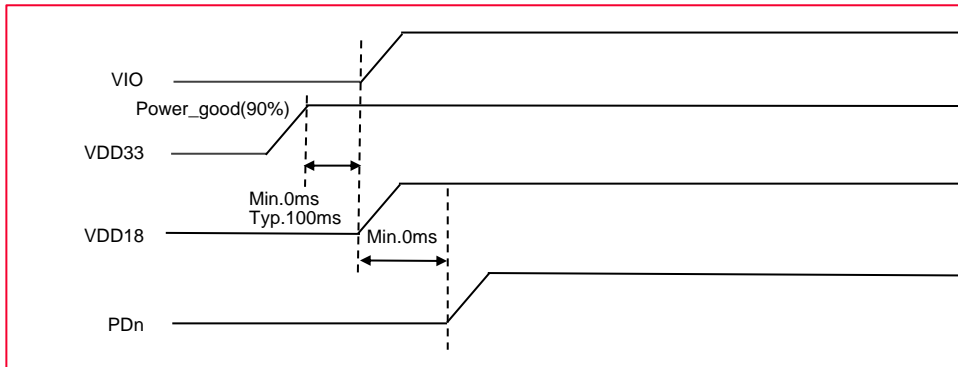

VIO_SD should be ramp-up before PDn assertion.

VIO should be the same as VDD18 or earlier. The VIO can ramp up after power_good state of VDD33. At that time the VDD18 can be the same or later than VIO.

10.2 Power-Off Sequence

Figure 8 shows the power-off sequence graph.

Figure 8: Power-Off Sequence Graph

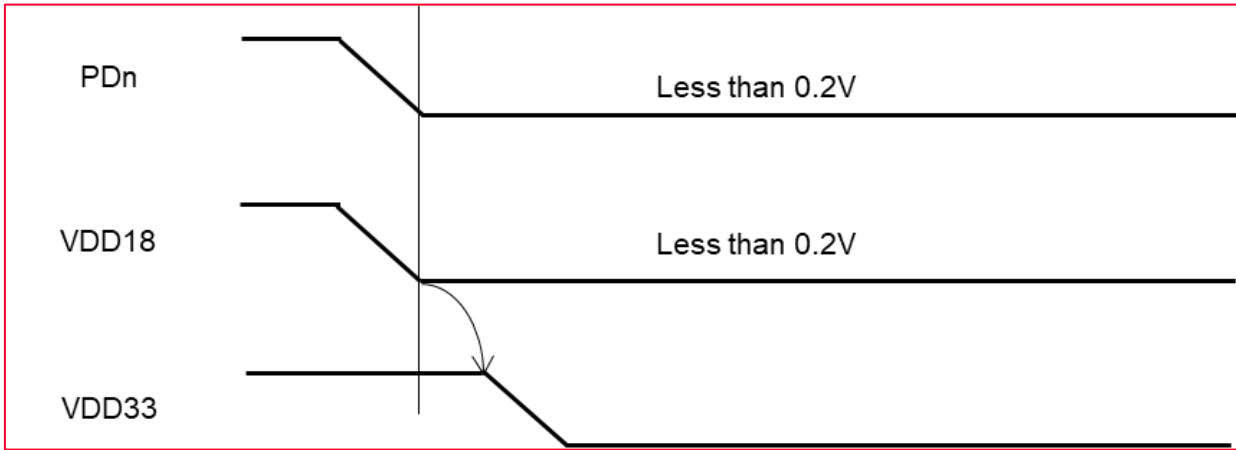

To reduce leakage, ramp down VDD18 before VDD33 when powering down the SoC.
Specific timing for VIO is not required for its power-down.
PDn must be discharged to less than 0.2 V before Power-On Reset (PDn) is triggered again.

11 Host Interface Specification

This section describes various SDIO specifications along with the SDIO timing data.

11.1 SDIO Specifications

- The SDIO host interface pins are powered from the VIO_SD voltage supply.
- The SDIO electrical specifications are identical for 4-bit SDIO transfer modes.

11.1.1 Default Speed, High Speed Modes

Figure 9 and Figure 10 shows the default and high speed modes.

Figure 9: SDIO Protocol Timing Diagram - Default Speed Mode (3.3V)

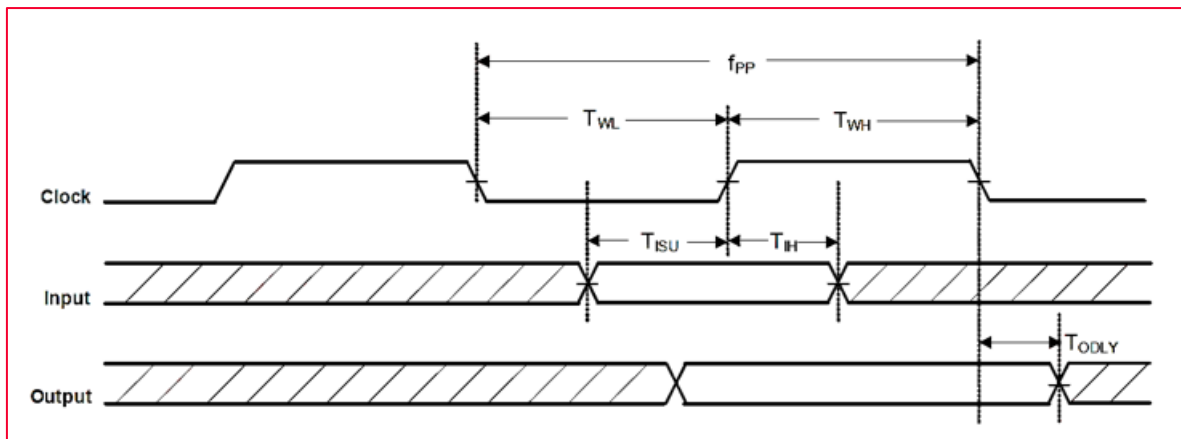

Figure 10: SDIO Protocol Timing Diagram - High Speed Mode (3.3V)

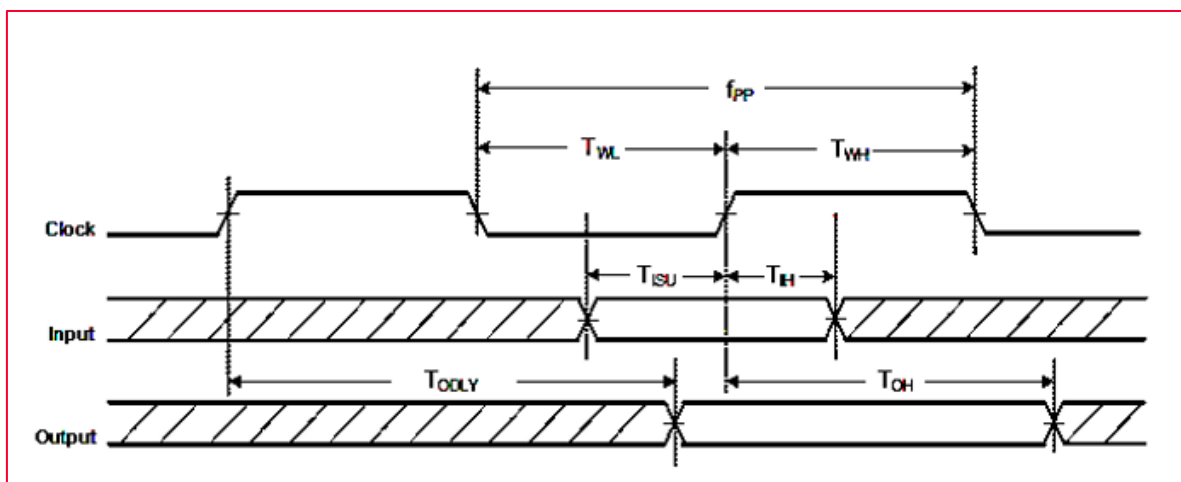

Table 14 shows the SDIO timing data at default and high speed modes.

Table 14: SDIO Timing Data - Default Speed, High Speed Modes (3.3V)

Symbol	Parameter	Condition	Minimum	Typical	Maximum	Unit
f _{PP}	Clock frequency	Normal	0		25	MHz
		High speed	0		50	MHz
T _{WL}	Clock low time	Normal	10			ns
		High speed	7			ns
T _{WH}	Clock high time	Normal	10			ns
		High speed	7			ns
T _{ISU}	Input setup time	Normal	5			ns
		High speed	6			ns
T _{IH}	Input hold time	Normal	5			ns
		High speed	2			ns
T _{ODLY}	Output delay time	Normal			14	ns
	CL ≤ 40 pF (1 card)	High speed			14	ns
T _{OH}	Output hold time	High speed	2.5			ns



Over full range of values specified in the Recommended Operating Conditions unless otherwise specified.

11.1.2 SDR12, SDR25, SDR50 Modes up to 100 MHz (1.8V)

Figure 11 shows the SDIO timing diagram for SDR12, SDR25, SDR50 modes for up to 100 MHz for 1.8V.

Figure 11: SDIO Protocol Timing Diagram - SDR12, SDR25, SDR50 Modes

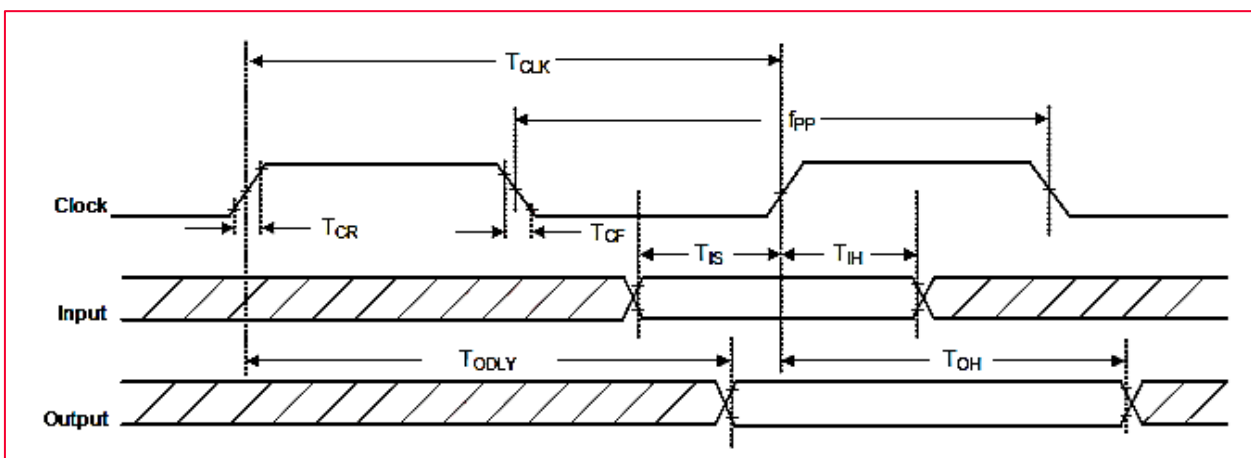

Table 15 shows the SDIO timing data for SDR12, SDR25, SDR50 modes up to 100 MHz (1.8V).

Table 15: SDIO Timing Data - SDR12, SDR25, SDR50 Modes

Symbol	Parameter	Condition	Minimum	Typical	Maximum	Unit
f_{PP}	Clock frequency	SDR12/25/50	25		100	MHz
T_{IS}	Input setup time	SDR12/25/50	3			ns
T_{IH}	Input hold time	SDR12/25/50	0.8			ns
T_{CLK}	Clock time	SDR12/25/50	10		40	ns
T_{CR}, T_{CF}	Rise time, fall time TCR, TCF < 2 ns (maximum) at 100 MHz CCARD = 10 pF	SDR12/25/50			$0.2 * T_{CLK}$	ns
T_{ODLY}	Output delay time CL ≤ 30 pF	SDR12/25/50			7.5	ns
T_{OH}	Output hold time CL = 15 pF	SDR12/25/50	1.5			ns



Over full range of values specified in the Recommended Operating Conditions unless otherwise specified.

11.1.3 SDR104 Mode at 208 MHz (1.8V)

Figure 12 shows the SDIO protocol timing diagram for SDR104 mode (208 MHz).

Figure 12: SDIO Protocol Timing Diagram - SDR104 Mode

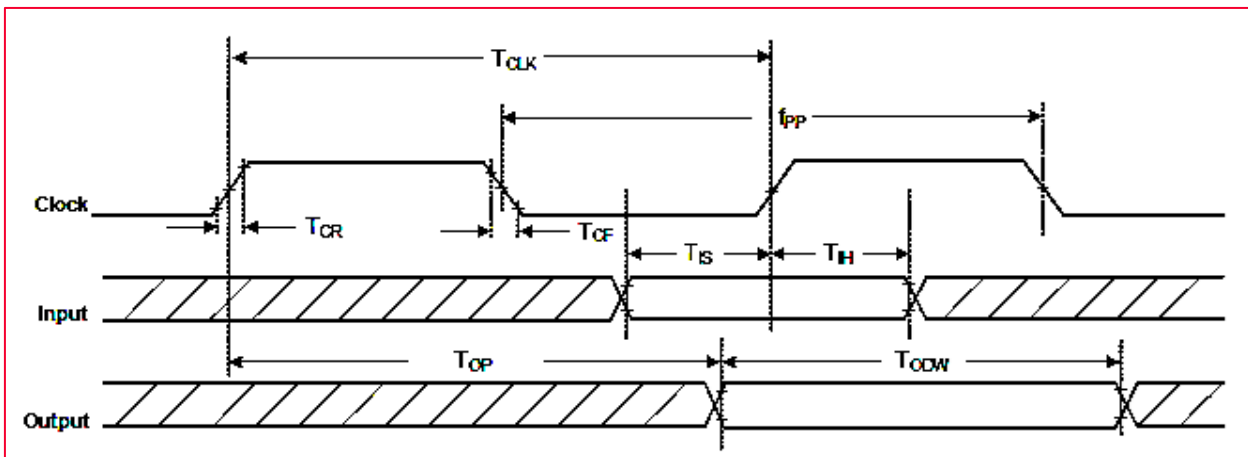

Table 16 shows the SDIO protocol timing data for SDR104 mode (208 MHz).

Table 16: SDIO Timing Data - SDR104 Mode

Symbol	Parameter	Condition	Minimum	Typical	Maximum	Unit
f_{PP}	Clock frequency	SDR104	0	-	208	MHz
T_{IS}	Input setup time	SDR104	1.4	-	-	ns
T_{IH}	Input hold time	SDR104	0.8	-	-	ns
T_{CLK}	Clock time	SDR104	4.8	-	-	ns
T_{CR}, T_{CF}	Rise time, fall time TCR, TCF < 0.96 ns (maximum) at 208 MHz CCARD = 10 pF	SDR104	-	-	$0.2 * T_{CLK}$	ns
T_{OP}	Card output phase	SDR104	0	-	10	ns
T_{ODW}	Output timing of variable data window	SDR104	2.88	-	-	ns



Over full range of values specified in the Recommended Operating Conditions unless otherwise specified.

11.1.4 DDR50 Mode at 50 MHz (1.8V)

Figure 13 shows SDIO CMD Timing Diagram for DDR50 Mode (50 MHz)

Figure 13: SDIO CMD Timing Diagram - DDR50 Mode

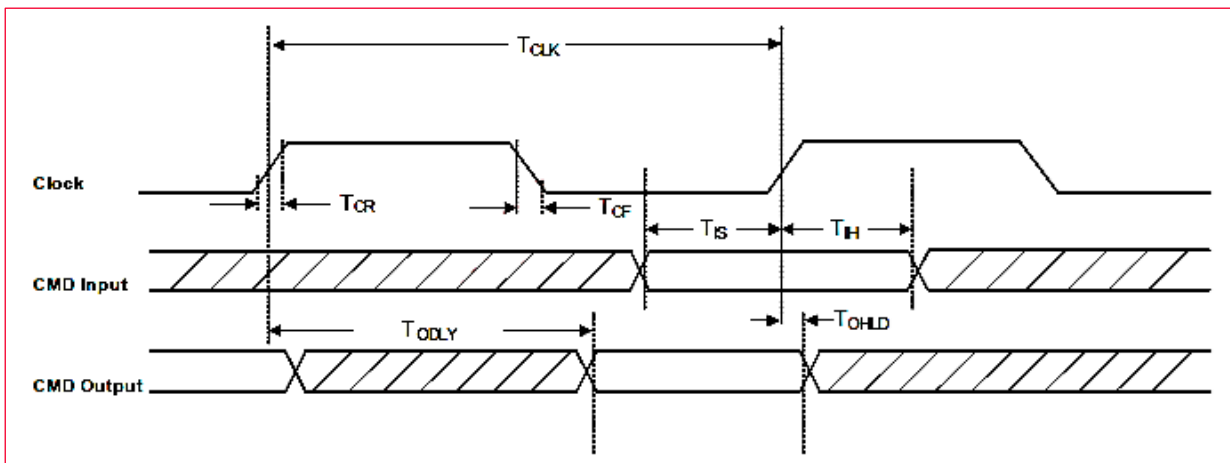
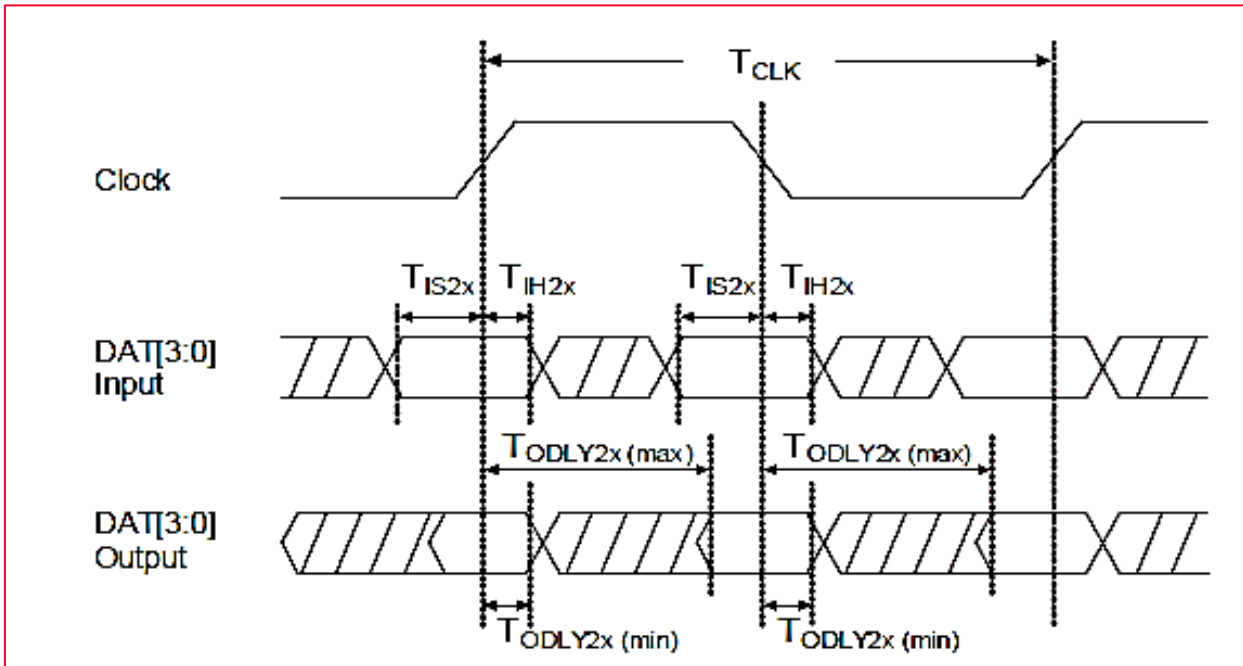

Figure 14 SDIO DAT[3:0] timing diagram for DDR50 mode at 50 MHz.

Figure 14: SDIO DAT[3:0] Timing Diagram - DDR50 Mode



Over full range of values specified in the Recommended Operating Conditions unless otherwise specified.

Table 17 shows the SDIO timing data for DDR50 mode.

Table 17: SDIO Timing Data - DDR50 Mode

Symbol	Parameter	Condition	Minimum	Typical	Maximum	Unit
Clock						
T_{CLK}	Clock time 50 MHz (maximum) between rising edges	DDR50	20			ns
T_{CR}, T_{CF}	Rise time, fall time $T_{CR}, T_{CF} < 4.00$ ns (maximum) at 50 MHz $C_{CARD} = 10$ pF	DDR50			$0.2 \cdot T_{CLK}$	ns
Clock Duty	-	DDR50	45		55	%
CMD Input (referenced to clock rising edge)						
T_{IS}	Input setup time $C_{CARD} \leq 10$ pF (1 card)	DDR50	6			ns
T_{IH}	Input hold time $C_{CARD} \leq 10$ pF (1 card)	DDR50	0.8			ns
CMD Output (referenced to clock rising edge)						

Symbol	Parameter	Condition	Minimum	Typical	Maximum	Unit
T _{ODLY}	Output delay time during data transfer mode C _L ≤ 30 pF (1 card)	DDR50			13.7	ns
Clock						
T _{OHLd}	Output hold time C _L ≥ 15 pF (1 card)	DDR50	1.5			ns
DAT[3:0] Input (referenced to clock rising and falling edges)						
T _{IS2x}	Input setup time C _{CARD} ≤ 10 pF (1 card)	DDR50	3			ns
T _{IH2x}	Input hold time C _{CARD} ≤ 10 pF (1 card)	DDR50	0.8			ns
DAT[3:0] Output (referenced to clock rising and falling edges)						
T _{ODLY2x (max)}	Output delay time during data transfer mode C _L ≤ 25 pF (1 card)	DDR50			7.0	ns
T _{ODLY2x (min)}	Output hold time C _L ≥ 15 pF (1 card)	DDR50	1.5			ns



Over full range of values specified in the Recommended Operating Conditions unless otherwise specified.

11.2 PCI Express Specifications

The PCI express host interface pins are powered from the AVDD18 voltage supply.

11.2.1 Differential Tx Output Electricals

This section describes the PCI express Tx output specifications data for 2.5 GT/s and 5 GT/s.



In accordance with PCI Express Base Specification, Revision 2.1 March 4, 2009.

Table 18 describes PCI express Tx output specifications data for 2.5 GT/s.

Table 18: PCI Express Tx Output Specifications Data - 2.5 GT/s

Symbol	Parameter	Minimum	Typical	Maximum	Unit
UI	Unit Interval (UI) The specified UI is equivalent to a tolerance of ± 300 ppm for each Refclk source. Period does not account for SSC induced variations.	399.88		400.12	ps
V _{TX-DIFF-PP}	Differential peak-to-peak Tx voltage swing $V_{TX-DIFF-PP} = 2 * V_{TXD+} - V_{TXD-} $	0.8		1.2	V
V _{TX-DIFF-PP-LOW}	Low power differential peak-to-peak Tx voltage swing $V_{TX-DIFF-PP} = 2 * V_{TXD+} - V_{TXD-} $	0.4		1.2	V
V _{TX-DE-RATIO-3.5dB}	Tx de-emphasis level ratio (3.5 dB)	3.0		4.0	dB
T _{TX-EYE}	Tx eye including all jitter sources	0.75			UI
T _{TX-EYE-MEDIAN-to-MAX-JITTER}	Maximum time between jitter median and maximum deviation from median.	-		0.125	UI
T _{TX-RISE-FALL}	Tx rise/fall time Measured differentially from 20% to 80% of swing.	0.125			UI
R _{LTX-DIFF}	Tx package plus Si differential return loss	10			dB
R _{LTX-CM}	Tx package plus Si common mode return loss	6			dB
V _{TX-CM-AC-P}	Tx AC common mode voltage		20		mV
I _{TX-SHORT}	Tx short circuit current limit			90	mA
V _{TX-DC-CM}	Tx DC common mode voltage	0		3.6	V
V _{TX-CM-DC-ACTIVE-IDLE-DELTA}	Absolute delta of DC common mode voltage during L0 and electrical idle	0		100	mV
V _{TX-IDLE-DIFF-AC-P}	Electrical idle differential peak output voltage	0		20	mV
V _{TX-RCV-DETECT}	Voltage change allowed during receiver detection			600	mV
T _{TX-IDLE-MIN}	Minimum time spent in electrical idle	20			ns
T _{TX-IDLE-SET-TO-IDLE}	Maximum time to transition to a valid electrical idle after sending an electrical idle ordered set			8	ns
T _{TX-IDLE-TO-DIFF-DATA}	Maximum time to transition to valid diff signaling after leaving electrical idle			8	ns
T _{CROSSLINK}	Crosslink random timeout			1.0	ms

Symbol	Parameter	Minimum	Typical	Maximum	Unit
C _{TX}	AC coupling capacitor	75		200	nF

Table 19 describes PCI express Tx output specifications data for 5 GT/s.



In accordance with PCI Express Base Specification, Revision 2.1 March 4, 2009.

Table 19: PCI Express Tx Output Specifications Data - 5 GT/s

Symbol	Parameter	Minimum	Typical	Maximum	Unit
UI	Unit Interval (UI) The specified UI is equivalent to a tolerance of ± 300 ppm for each Refclk source. Period does not account for SSC induced variations.	199.94		200.06	ps
V _{TX-DIFFpp}	Differential peak-to-peak Tx voltage swing $V_{TX-DIFFpp} = 2 * V_{TXD+} - V_{TXD-} $	0.8		1.2	V
V _{TX-DIFFpp-LOW}	Low power differential peak-to-peak Tx voltage swing $V_{TX-DIFFpp} = 2 * V_{TXD+} - V_{TXD-} $	0.4		1.2	V
V _{TX-DE-RATIO-3.5dB}	Tx de-emphasis level ratio (3.5 dB)	3.0		4.0	dB
V _{TX-DE-RATIO-6dB}	Tx de-emphasis level ratio (6 dB)	5.5		6.5	dB
T _{MIN-PULSE}	Instantaneous lone pulse width Measured relative to rising/falling pulse.	0.9			UI
T _{TX-EYE}	Tx eye including all jitter sources	0.75			UI
T _{TX-HF-DJ-DD}	Tx deterministic jitter > 1.5 MHz Deterministic jitter only.			0.15	UI
T _{TX-LF-RMS}	Tx RMS jitter < 1.5 MHz Total energy measured over a 10 kHz - 1.5 MHz range.		3.0		Ps RMS
T _{TX-RISE-FALL}	Tx rise/fall time Measured differentially from 20% to 80% of swing.	0.15			UI
RL _{TX-DIFF}	Tx package plus Si differential return loss (1.25-2.5 GHz)	10			dB
	Tx package plus Si differential return loss (0.05-1.25 GHz)	8			
RL _{TX-CM}	Tx package plus Si common mode return loss	6			dB
V _{TX-CM-AC-PP}	Tx AC common mode voltage			100	mVPP
I _{TX-SHORT}	Tx short circuit current limit			90	mA

Symbol	Parameter	Minimum	Typical	Maximum	Unit
V _{TX-DC-CM}	Tx DC common mode voltage	0		3.6	V
V _{TX-CM-DC-ACTIVE-IDLE-DELTA}	Absolute delta of DC common mode voltage during L0 and electrical idle	0		100	mV
V _{TX-IDLE-DIFF-AC-p}	Electrical idle differential peak output voltage $V_{TX-IDLE-DIFF-DC} = V_{TX-IDLE-D+} - V_{TX-IDLE-D-} \leq 20 \text{ mV}$	0		20	mV
V _{TX-IDLE-DIFF-DC}	DC Electrical idle differential peak output voltage $V_{TX-IDLE-DIFF-DC} = V_{TX-IDLE-D+} - V_{TX-IDLE-D-} \leq 5 \text{ mV}$	0		5	mV
V _{TX-RCV-DETECT}	Voltage change allowed during receiver detection			600	mV
T _{TX-IDLE-MIN}	Minimum time spent in electrical idle	20			ns
T _{TX-IDLE-SET-TO-IDLE}	Maximum time to transition to a valid electrical idle after sending an electrical idle ordered set.			8	ns
T _{TX-IDLE-TO-DIFF-DATA}	Maximum time to transition to valid differential signaling after leaving electrical idle.			8	ns
T _{CROSSLINK}	Crosslink random timeout			1.0	ms
C _{TX}	AC coupling capacitor	75		200	nF

11.2.2 Differential Rx Input Electricals

This section describes the PCI express Rx input specifications data for 2.5 GT/s and 5 GT/s.



In accordance with PCI Express Base Specification, Revision 2.1 March 4, 2009.

Table 20 describes the PCI express Rx input specifications data for 2.5 GT/s.

Table 20: PCI Express Rx Input Specifications Data - 2.5 GT/s

Symbol	Parameter	Minimum	Typical	Maximum	Unit
UI	Unit Interval (UI) UI does not account for SSC induced variations.	399.88		400.12	ps
V _{RX-DIFF-PP-CC}	Differential Rx peak-to-peak voltage for common Refclk Rx architecture	0.175		1.2	V
V _{RX-DIFF-PP-DC}	Differential Rx peak-to-peak voltage for data clocked Rx architecture	0.175		1.2	V
T _{RX-EYE}	Rx eye time opening. Minimum eye time at Rx pins to yield a 10 ⁻¹² BER.	0.40			UI
T _{RX-EYE-MEDIAN-to-MAX-JITTER}	Maximum time delta between median and deviation from median			0.3	UI
V _{RX-CM-ACp}	AC peak common mode input voltage			150	mV
RL _{RX-DIFF}	Differential return loss	15			dB
RL _{RX-CM}	Common mode return loss	0		3.6	dB
Z _{RX-DIFF-DC}	DC differential input impedance	80	100	120	W
Z _{RX-DC}	DC input impedance	40	50	60	W
Z _{RX-HIGH-IMP-DC}	Powered down DC input impedance	200			kΩ
V _{RX-IDLE-DET-DIFF-p-p}	Electrical idle detect threshold	65		175	mV
T _{RX-IDLE-DET-DIFF-ENTERTIME}	Unexpected electrical idle enter detect threshold integration time			10	ms
L _{RX-SKEW}	Total skew			20	ns

Table 21 describes the PCI express Rx input specifications data for 5 GT/s.



In accordance with PCI Express Base Specification, Revision 2.1 March 4, 2009.

Table 21: PCI Express Rx Input Specifications Data - 5 GT/s

Symbol	Parameter	Minimum	Typical	Maximum	Unit
UI	Unit Interval (UI) UI does not account for SSC induced variations.	199.94		200.06	ps
V _{RX-DIFF-PP-CC}	Differential Rx peak-to-peak voltage for common Refclk Rx architecture	0.120		1.2	V
V _{RX-DIFF-PP-DC}	Differential Rx peak-to-peak voltage for data clocked Rx architecture	0.100		1.2	V
T _{RX-TJ-CC}	Maximum Rx inherent total timing error for common Refclk Rx architecture			0.40	UI
T _{RX-TJ-DC}	Maximum Rx inherent total timing error for data clocked Rx architecture			0.34	UI
T _{RX-DJ-DD-CC}	Maximum Rx inherent deterministic timing error for common Refclk Rx architecture			0.30	UI
T _{RX-DJ-DD-DC}	Maximum Rx inherent deterministic timing error for data clocked Rx architecture			0.24	UI
T _{RX-MIN-PLISE}	Minimum width pulse at Rx Measured to account for worst T _j at 10 ⁻¹² BER.	0.6			UI
V _{RX-CM-ACp}	AC peak common mode input voltage			150	mV
R _L _{RX-DIFF}	Differential return loss	15			dB
R _L _{RX-CM}	Common mode return loss	0		3.6	dB
Z _{RX-DIFF-DC}	DC differential input impedance	80	100	120	W
Z _{RX-DC}	DC input impedance	40	50	60	W
Z _{RX-HIGH-IMP-DC}	Powered down DC input impedance	200			kΩ
V _{RX-IDLE-DET-DIFF-p-p}	Electrical idle detect threshold	65		175	mV
T _{RX-IDLE-DET-DIFF-ENTERTIME}	Unexpected electrical idle enter detect threshold integration time			10	ms
L _{RX-SKEW}	Total skew			20	ns

12 DC/RF Characteristics

ALL DC/RF characteristics are defined by the files listed in **Table 22**.

Table 22: DC/RF Characteristic Files

Characteristics	Filenames
WLAN Tx Power	txpower_US.bin, txpower_CA.bin, txpower_EU.bin, txpower_JP.bin
WLAN Regulatory Limit	db.txt
Energy Detect	ed_mac.bin
Bluetooth Power	bt_power_config_1.sh (Class 1)

Figure 15 shows the burst current definition.

Figure 15: Burst Current Definition

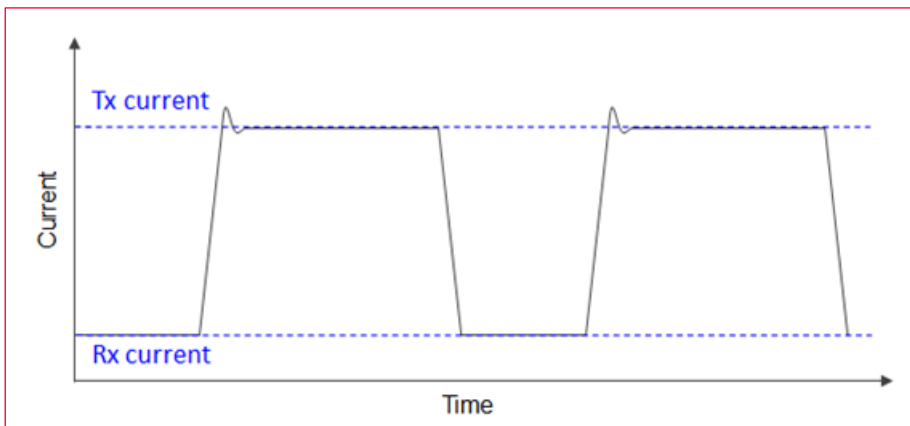

12.1 DC/RF Characteristics for IEEE 802.11b - 2.4 GHz

Table 23: DC/RF Characteristics for IEEE 802.11b - 2.4 GHz

Items	Contents
Specification	IEEE 802.11b
Mode	DSSS / CCK
Channel Frequency	2412 to 2472 MHz
Data rate	1, 2, 5.5, 11 Mbps

12.1.1 High-Rate Condition for IEEE 802.11b - 2.4 GHz

Conditions: 25 °C, VDD33 = 3.3V, VDD18 = 1.8V, VIO = 1.8V, Output power setting = 18 dBm, 11 Mbps mode

Table 24: High-Rate Condition for IEEE 802.11b - 2.4 GHz

Items		Contents			
DC Characteristics		Minimum	Typical	Maximum	Unit
DC current					
• Tx mode	VDD18		280		mA
	VDD33		220		mA
	VDD18 (MIMO)		370		mA
	VDD33 (MIMO)		450		mA
• Rx mode	VDD18		280		mA
	VDD33		0.2		mA
	VDD18 (MIMO)		300		mA
	VDD33 (MIMO)		0.2		mA
Tx Characteristics		Minimum	Typical	Maximum	Unit
Output Power		16	18	20	dBm
Spectrum Mask Margin					
• 1st side lobes (-30dBr)		0			dB
• 2nd side lobes (-50dBr)		0			dB
Power-on/off ramp				2.0	μs
RF Carrier Suppression		15		-	dB
Modulation Accuracy				35	%
Frequency Tolerance		-20		20	ppm
Spurious Emissions					
• 30 - 47 MHz (BW = 100 kHz)				-36	dBm
• 47 - 74 MHz (BW = 100 kHz)				-54	dBm
• 74 - 87.5 MHz (BW = 100 kHz)				-36	dBm
• 87.5 - 118 MHz (BW = 100 kHz)				-54	dBm
• 118 - 174 MHz (BW = 100 kHz)				-36	dBm
• 174 - 230 MHz (BW = 100 kHz)				-54	dBm
• 230 - 470 MHz (BW = 100 kHz)				-36	dBm
• 470 - 862 MHz (BW = 100 kHz)				-54	dBm
• 862 - 1000 MHz (BW = 100 kHz)				-36	dBm
• 1000 - 12750 MHz (BW = 1 MHz)				-30	dBm

Items	Contents			
Rx Characteristics	Minimum	Typical	Maximum	Unit
Minimum Input Level (FER ≤ 8%)			-76	dBm
Maximum Input Level (FER ≤ 8%)	-10			dBm
Adjacent Channel Rejection (FER < 8%)	35			dB

12.1.2 Low-Rate Condition for IEEE 802.11b - 2.4 GHz

Conditions: 25 °C, VDD33 = 3.3V, VDD18 = 1.8V VIO = 1.8V, Output power setting = 18 dBm, 1 Mbps mode

Table 25: Low-Rate Condition for IEEE 802.11b - 2.4 GHz

Items	Contents			
DC Characteristics	Minimum	Typical	Maximum	Unit
DC current				
• Tx mode	VDD18	280		mA
	VDD33	210		mA
	VDD18 (MIMO)	370		mA
	VDD33 (MIMO)	450		mA
• Rx mode	VDD18	280		mA
	VDD33	0.2		mA
	VDD18 (MIMO)	300		mA
	VDD33 (MIMO)	0.2		mA
Tx Characteristics	Minimum	Typical	Maximum	Unit
Output Power	16	18	20	dBm
Spectrum Mask Margin				
• 1st side lobes (-30dBr)	0			dB
• 2nd side lobes (-50dBr)	0			dB
Power-on/off ramp			2.0	μs
RF Carrier Suppression	15			dB
Modulation Accuracy			35	%
Frequency Tolerance	-20		20	ppm
Spurious Emissions				
• 30 - 47 MHz (BW = 100 kHz)			-36	dBm
• 47 - 74 MHz (BW = 100 kHz)			-54	dBm
• 74 - 87.5 MHz (BW = 100 kHz)			-36	dBm
• 87.5 - 118 MHz (BW = 100 kHz)			-54	dBm
• 118 - 174 MHz (BW = 100 kHz)			-36	dBm
• 174 - 230 MHz (BW = 100 kHz)			-54	dBm
• 230 - 470 MHz (BW = 100 kHz)			-36	dBm
• 470 - 862 MHz (BW = 100 kHz)			-54	dBm
• 862 - 1000 MHz (BW = 100 kHz)			-36	dBm
• 1000 - 12750 MHz (BW = 1 MHz)			-30	dBm
Rx Characteristics	Minimum	Typical	Maximum	Unit
Minimum Input Level (FER ≤ 8%)			-80	dBm
Maximum Input Level (FER ≤ 8%)	-10			dBm
Adjacent Channel Rejection (FER < 8%)	35			dB

12.2 DC/RF Characteristics for IEEE 802.11g - 2.4 GHz

Table 26: DC/RF Characteristics for IEEE 802.11g - 2.4 GHz

Items	Contents
Specification	IEEE 802.11g
Mode	OFDM
Channel Frequency	2412 to 2472 MHz
Data rate	6, 9, 12, 18, 24, 36, 48, 54 Mbps

12.2.1 High-Rate Condition for IEEE 802.11g - 2.4 GHz

Conditions: 25 °C, VDD33 = 3.3V, VDD18 = 1.8V VIO = 1.8V, Output power setting = 16 dBm, 54 Mbps mode

Table 27: High-Rate Condition for IEEE 802.11g - 2.4 GHz

Items		Contents			
DC Characteristics		Minimum	Typical	Maximum	Unit
DC current					
• Tx mode	VDD18		300		mA
	VDD33		180		mA
	VDD18 (MIMO)		410		mA
	VDD33 (MIMO)		370		mA
• Rx mode	VDD18		280		mA
	VDD33		0.2		mA
	VDD18 (MIMO)		300		mA
	VDD33 (MIMO)		0.2		mA
Tx Characteristics		Minimum	Typical	Maximum	Unit
Output Power		14	16	18	dBm
Spectrum Mask Margin					
• 9 MHz to 11 MHz (0 ~ -20 dBr)		0			dB
	• 11 MHz to 20 MHz (-20 ~ -28 dBr)	0			dB
	• 20 MHz to 30 MHz (-28 ~ -40 dBr)	0			dB
	• 30 MHz to 33 MHz (-40 dBr)	0			dB
Constellation Error (EVM)				-25	dB
Frequency Tolerance		-20		20	ppm
Spurious Emissions					
• 30 - 47 MHz (BW = 100 kHz)				-36	dBm
• 47 - 74 MHz (BW = 100 kHz)				-54	dBm
• 74 - 87.5 MHz (BW = 100 kHz)				-36	dBm
• 87.5 - 118 MHz (BW = 100 kHz)				-54	dBm
• 118 - 174 MHz (BW = 100 kHz)				-36	dBm
• 174 - 230 MHz (BW = 100 kHz)				-54	dBm
• 230 - 470 MHz (BW = 100 kHz)				-36	dBm
• 470 - 862 MHz (BW = 100 kHz)				-54	dBm
• 862 - 1000 MHz (BW = 100 kHz)				-36	dBm
• 1000 - 12750 MHz (BW = 1 MHz)				-30	dBm

Items	Contents			
Rx Characteristics	Minimum	Typical	Maximum	Unit
Minimum Input Level (PER < 10%)			-65	dBm
Maximum Input Level (PER < 10%)	-20			dBm
Adjacent Channel Rejection (PER < 10%)	-1			dB

12.2.2 Low-Rate Condition for IEEE 802.11g - 2.4 GHz

Conditions: 25 °C, VDD33 = 3.3V, VDD18 = 1.8V VIO = 1.8V, Output power setting = 17 dBm, 6 Mbps mode

Table 28: Low-Rate Condition for IEEE 802.11g - 2.4 GHz

Items	Contents			
DC Characteristics	Minimum	Typical	Maximum	Unit
DC current				
• Tx mode	VDD18	300		mA
	VDD33	200		mA
	VDD18 (MIMO)	410		mA
	VDD33 (MIMO)	420		mA
• Rx mode	VDD18	280		mA
	VDD33	0.2		mA
	VDD18 (MIMO)	300		mA
	VDD33 (MIMO)	0.2		mA
Tx Characteristics	Minimum	Typical	Maximum	Unit
Output Power	15	17	19	dBm
Spectrum Mask Margin				
• 9 MHz to 11 MHz (0 ~ -20 dBr)	0			dB
• 11 MHz to 20 MHz (-20 ~ -28 dBr)	0			dB
• 20 MHz to 30 MHz (-28 ~ -40 dBr)	0			dB
• 30 MHz to 33 MHz (-40 dBr)	0			dB
Constellation Error (EVM)			-25	dB
Frequency Tolerance	-20		20	ppm
Spurious Emissions				
• 30 - 47 MHz (BW = 100 kHz)			-36	dBm
• 47 - 74 MHz (BW = 100 kHz)			-54	dBm
• 74 - 87.5 MHz (BW = 100 kHz)			-36	dBm
• 87.5 - 118 MHz (BW = 100 kHz)			-54	dBm
• 118 - 174 MHz (BW = 100 kHz)			-36	dBm
• 174 - 230 MHz (BW = 100 kHz)			-54	dBm
• 230 - 470 MHz (BW = 100 kHz)			-36	dBm
• 470 - 862 MHz (BW = 100 kHz)			-54	dBm
• 862 - 1000 MHz (BW = 100 kHz)			-36	dBm
• 1000 - 12750 MHz (BW = 1 MHz)			-30	dBm
Rx Characteristics	Minimum	Typical	Maximum	Unit
Minimum Input Level (PER < 10%)			-82	dBm
Maximum Input Level (PER < 10%)	-20			dBm
Adjacent Channel Rejection (PER < 10%)	-1			dB

12.3 DC/RF Characteristics for IEEE 802.11n - 2.4 GHz

Table 29: DC/RF Characteristics for IEEE 802.11n - 2.4 GHz

Items	Contents
Specification	IEEE 802.11n
Mode	OFDM
Channel Frequency	2412 to 2472 MHz
Data rate	MCS0 - MCS7

12.3.1 High-Rate Condition for IEEE 802.11n - 2.4 GHz

Conditions: 25 °C, VDD33 = 3.3V, VDD18 = 1.8V VIO = 1.8V, Output power setting = 15 dBm, MCS7 mode

Table 30: High-Rate Condition for IEEE 802.11n - 2.4 GHz

Items	Contents			
DC Characteristics	Minimum	Typical	Maximum	Unit
DC current				
• Tx mode	VDD18	300		mA
	VDD33	170		mA
	VDD18 (MIMO)	410		mA
	VDD33 (MIMO)	330		mA
• Rx mode	VDD18	280		mA
	VDD33	0.2		mA
	VDD18 (MIMO)	300		mA
	VDD33 (MIMO)	0.2		mA
Tx Characteristics	Minimum	Typical	Maximum	Unit
Output Power	13	15	17	dBm
Spectrum Mask Margin				
• 9 MHz to 11 MHz (0 ~ -20 dBr)	0			dB
• 11 MHz to 20 MHz (-20 ~ -28 dBr)	0			dB
• 20 MHz to 30 MHz (-28 ~ -45 dBr)	0			dB
• 30 MHz to 33 MHz (-45 dBr)	0			dB
Constellation Error (EVM) (Measured at enhanced mode)			-27	dB
Frequency Tolerance	-20		20	ppm
Spurious Emissions				
• 30 - 47 MHz (BW = 100 kHz)			-36	dBm
• 47 - 74 MHz (BW = 100 kHz)			-54	dBm
• 74 - 87.5 MHz (BW = 100 kHz)			-36	dBm
• 87.5 - 118 MHz (BW = 100 kHz)			-54	dBm
• 118 - 174 MHz (BW = 100 kHz)			-36	dBm
• 174 - 230 MHz (BW = 100 kHz)			-54	dBm
• 230 - 470 MHz (BW = 100 kHz)			-36	dBm
• 470 - 862 MHz (BW = 100 kHz)			-54	dBm
• 862 - 1000 MHz (BW = 100 kHz)			-36	dBm
• 1000 - 12750 MHz (BW = 1 MHz)			-30	dBm
Rx Characteristics	Minimum	Typical	Maximum	Unit

Items	Contents			
Minimum Input Level (PER ≤ 10%)			-64	dBm
Maximum Input Level (PER < 10%)	-20			dBm
Adjacent Channel Rejection (PER ≤ 10%)	-2			dB

12.3.2 Low-Rate Condition for IEEE 802.11n - 2.4 GHz

Conditions: 25 °C, VDD33 = 3.3V, VDD18 = 1.8V VIO = 1.8V, Output power setting = 16 dBm, MCS0 mode

Table 31: Low-Rate Condition for IEEE 802.11n - 2.4 GHz

Items		Contents			
DC Characteristics		Minimum	Typical	Maximum	Unit
DC current					
• Tx mode	VDD18		300		mA
	VDD33		190		mA
	VDD18 (MIMO)		410		mA
	VDD33 (MIMO)		380		mA
• Rx mode	VDD18		280		mA
	VDD33		0.2		mA
	VDD18 (MIMO)		300		mA
	VDD33 (MIMO)		0.2		mA
Tx Characteristics		Minimum	Typical	Maximum	Unit
Output Power		14	16	18	dBm
Spectrum Mask Margin					
• 9 MHz to 11 MHz (0 ~ -20 dBr)		0			dB
• 11 MHz to 20 MHz (-20 ~ -28 dBr)		0			dB
• 20 MHz to 30 MHz (-28 ~ -45 dBr)		0			dB
• 30 MHz to 33 MHz (-45 dBr)		0			dB
Constellation Error (EVM) (Measured at enhanced mode)				-27	dB
Frequency Tolerance		-20		20	ppm
Spurious Emissions					
• 30 - 47 MHz (BW = 100 kHz)				-36	dBm
• 47 - 74 MHz (BW = 100 kHz)				-54	dBm
• 74 - 87.5 MHz (BW = 100 kHz)				-36	dBm
• 87.5 - 118 MHz (BW = 100 kHz)				-54	dBm
• 118 - 174 MHz (BW = 100 kHz)				-36	dBm
• 174 - 230 MHz (BW = 100 kHz)				-54	dBm
• 230 - 470 MHz (BW = 100 kHz)				-36	dBm
• 470 - 862 MHz (BW = 100 kHz)				-54	dBm
• 862 - 1000 MHz (BW = 100 kHz)				-36	dBm
• 1000 - 12750 MHz (BW = 1 MHz)				-30	dBm
Rx Characteristics		Minimum	Typical	Maximum	Unit
Minimum Input Level (PER ≤ 10%)				-82	dBm
Maximum Input Level (PER < 10%)		-20			dBm
Adjacent Channel Rejection (PER ≤ 10%)		-2			dB

12.4 DC/RF Characteristics for IEEE 802.11ax - 2.4 GHz

Table 32: DC/RF Characteristics for IEEE 802.11ax - 2.4 GHz

Items	Contents
Specification	IEEE 802.11ax
Mode	OFDM
Channel Frequency	2412 to 2472 MHz
Data rate	MCS0 - MCS11

12.4.1 High-Rate Condition for IEEE 802.11ax - 2.4 GHz

Conditions: 25 °C, VDD33 = 3.3V, VDD18 = 1.8V VIO = 1.8V, Output power setting = 13 dBm, MCS11 mode

Table 33: High-Rate Condition for IEEE 802.11ax - 2.4 GHz

Items		Contents			
DC Characteristics		Minimum	Typical	Maximum	Unit
DC current					
• Tx mode	VDD18		300		mA
	VDD33		150		mA
	VDD18 (MIMO)		410		mA
	VDD33 (MIMO)		300		mA
• Rx mode	VDD18		280		mA
	VDD33		0.2		mA
	VDD18 (MIMO)		300		mA
	VDD33 (MIMO)		0.2		mA
Tx Characteristics		Minimum	Typical	Maximum	Unit
Output Power		11	13	15	dBm
Spectrum Mask Margin					
• 9 MHz to 11 MHz (0 ~ -20 dBr)		0			dB
• 11 MHz to 20 MHz (-20 ~ -28 dBr)		0			dB
• 20 MHz to 30 MHz (-28 ~ -40 dBr)		0			dB
• 30 MHz to 33 MHz (-40 dBr)		0			dB
Constellation Error (EVM) (Measured at enhanced mode)				-35	dB
Frequency Tolerance		-20		20	ppm
Spurious Emissions					
• 30 - 47 MHz (BW = 100 kHz)				-36	dBm
• 47 - 74 MHz (BW = 100 kHz)				-54	dBm
• 74 - 87.5 MHz (BW = 100 kHz)				-36	dBm
• 87.5 - 118 MHz (BW = 100 kHz)				-54	dBm
• 118 - 174 MHz (BW = 100 kHz)				-36	dBm
• 174 - 230 MHz (BW = 100 kHz)				-54	dBm
• 230 - 470 MHz (BW = 100 kHz)				-36	dBm
• 470 - 862 MHz (BW = 100 kHz)				-54	dBm
• 862 - 1000 MHz (BW = 100 kHz)				-36	dBm
• 1000 - 12750 MHz (BW = 1 MHz)				-30	dBm
Rx Characteristics		Minimum	Typical	Maximum	Unit

Items	Contents			
Minimum Input Level (PER ≤ 10%)			-69	dBm
Maximum Input Level (PER < 10%)	-20			dBm
Adjacent Channel Rejection (PER ≤ 10%)	-2			dB

12.4.2 Low-Rate Condition for IEEE 802.11ax - 2.4 GHz

Conditions: 25 °C, VDD33 = 3.3V, VDD18 = 1.8V VIO = 1.8V, Output power setting = 16 dBm, MCS0 mode

Table 34: Low-Rate Condition for IEEE 802.11ax - 2.4 GHz

Items		Contents			
DC Characteristics		Minimum	Typical	Maximum	Unit
DC current					
• Tx mode	VDD18		300		mA
	VDD33		190		mA
	VDD18 (MIMO)		420		mA
	VDD33 (MIMO)		390		mA
• Rx mode	VDD18		280		mA
	VDD33		0.2		mA
	VDD18 (MIMO)		300		mA
	VDD33 (MIMO)		0.2		mA
Tx Characteristics		Minimum	Typical	Maximum	Unit
Output Power		14	16	18	dBm
Spectrum Mask Margin					
• 9 MHz to 11 MHz (0 ~ -20 dBr)		0			dB
• 11 MHz to 20 MHz (-20 ~ -28 dBr)		0			dB
• 20 MHz to 30 MHz (-28 ~ --40 dBr)		0			dB
• 30 MHz to 33 MHz (--40 dBr)		0			dB
Constellation Error (EVM) (Measured at enhanced mode)				-19	dB
Frequency Tolerance		-20		20	ppm
Spurious Emissions					
• 30 - 47 MHz (BW = 100 kHz)				-36	dBm
• 47 - 74 MHz (BW = 100 kHz)				-54	dBm
• 74 - 87.5 MHz (BW = 100 kHz)				-36	dBm
• 87.5 - 118 MHz (BW = 100 kHz)				-54	dBm
• 118 - 174 MHz (BW = 100 kHz)				-36	dBm
• 174 - 230 MHz (BW = 100 kHz)				-54	dBm
• 230 - 470 MHz (BW = 100 kHz)				-36	dBm
• 470 - 862 MHz (BW = 100 kHz)				-54	dBm
• 862 - 1000 MHz (BW = 100 kHz)				-36	dBm
• 1000 - 12750 MHz (BW = 1 MHz)				-30	dBm
Rx Characteristics		Minimum	Typical	Maximum	Unit
Minimum Input Level (PER ≤ 10%)				-69	dBm
Maximum Input Level (PER < 10%)		-20			dBm
Adjacent Channel Rejection (PER ≤ 10%)		-2			dB

12.5 DC/RF Characteristics for IEEE 802.11a - 5 GHz

Table 35: DC/RF Characteristics for IEEE 802.11a - 5 GHz

Items	Contents
Specification	IEEE 802.11a
Mode	OFDM
Channel Frequency	5180 to 5240 MHz 5260 to 5320 MHz 5500 to 5720 MHz 5745 to 5825 MHz
Data rate	6, 9, 12, 18, 24, 36, 48, 54 Mbps

12.5.1 High-Rate Condition for IEEE 802.11a - 5 GHz

Conditions: 25 °C, VDD33 = 3.3V, VDD18 = 1.8V VIO = 1.8V, Output power setting = 16 dBm, 54 Mbps mode

Table 36: High-Rate Condition for IEEE 802.11a - 5 GHz

Items	Contents			
DC Characteristics	Minimum	Typical	Maximum	Unit
DC current				
• Tx mode	VDD18	400		mA
	VDD33	230		mA
	VDD18 (MIMO)	620		mA
	VDD33 (MIMO)	460		mA
• Rx mode	VDD18	320		mA
	VDD33	0.2		mA
	VDD18 (MIMO)	320		mA
	VDD33 (MIMO)	0.2		mA
Tx Characteristics	Minimum	Typical	Maximum	Unit
Output Power	14	16	18	dBm
Spectrum Mask Margin				
• 9 MHz to 11 MHz (0 ~ -20 dBr)	0			dB
• 11 MHz to 20 MHz (-20 ~ -28 dBr)	0			dB
• 20 MHz to 30 MHz (-28 ~ --40 dBr)	0			dB
• 30 MHz to 33 MHz (--40 dBr)	0			dB
Constellation Error (EVM) (Measured at enhanced mode)			-25	dB
Frequency Tolerance	-20		20	ppm
Spurious Emissions				
• 30 - 47 MHz (BW = 100 kHz)			-36	dBm
• 47 - 74 MHz (BW = 100 kHz)			-54	dBm
• 74 - 87.5 MHz (BW = 100 kHz)			-36	dBm
• 87.5 - 118 MHz (BW = 100 kHz)			-54	dBm
• 118 - 174 MHz (BW = 100 kHz)			-36	dBm
• 174 - 230 MHz (BW = 100 kHz)			-54	dBm
• 230 - 470 MHz (BW = 100 kHz)			-36	dBm
• 470 - 862 MHz (BW = 100 kHz)			-54	dBm

Items	Contents			
• 862 - 1000 MHz (BW = 100 kHz)			-36	dBm
• 1000 - 5150 MHz (BW = 1 MHz)			-30	dBm
• 5350 - 5470 MHz (BW = 1 MHz)			-30	dBm
• 5725 - 26000 MHz (BW = 1 MHz)			-30	dBm
Rx Characteristics	Minimum	Typical	Maximum	Unit
Minimum Input Level (PER ≤ 10%)			-65	dBm
Maximum Input Level (PER < 10%)	-30			dBm
Adjacent Channel Rejection (PER ≤ 10%)	-1			dB

12.5.2 Low-Rate Condition for IEEE 802.11a - 5 GHz

Conditions: 25 °C, VDD33 = 3.3V, VDD18 = 1.8V VIO = 1.8V, Output power setting = 17 dBm, 6 Mbps mode

Table 37: Low-Rate Condition for IEEE 802.11a - 5 GHz

Items	Contents			
DC Characteristics	Minimum	Typical	Maximum	Unit
DC current				
• Tx mode	VDD18	430		mA
	VDD33	260		mA
	VDD18 (MIMO)	610		mA
	VDD33 (MIMO)	510		mA
• Rx mode	VDD18	320		mA
	VDD33	0.2		mA
	VDD18 (MIMO)	320		mA
	VDD33 (MIMO)	0.2		mA
Tx Characteristics	Minimum	Typical	Maximum	Unit
Output Power	15	17	19	dBm
Spectrum Mask Margin				
• 9 MHz to 11 MHz (0 ~ -20 dBr)	0			dB
• 11 MHz to 20 MHz (-20 ~ -28 dBr)	0			dB
• 20 MHz to 30 MHz (-28 ~ -45 dBr)	0			dB
• 30 MHz to 33 MHz (-45 dBr)	0			dB
Constellation Error (EVM) (Measured at enhanced mode)			-25	dB
Frequency Tolerance	-20		20	ppm
Spurious Emissions				
• 30 - 47 MHz (BW = 100 kHz)			-36	dBm
• 47 - 74 MHz (BW = 100 kHz)			-54	dBm
• 74 - 87.5 MHz (BW = 100 kHz)			-36	dBm
• 87.5 - 118 MHz (BW = 100 kHz)			-54	dBm
• 118 - 174 MHz (BW = 100 kHz)			-36	dBm
• 174 - 230 MHz (BW = 100 kHz)			-54	dBm
• 230 - 470 MHz (BW = 100 kHz)			-36	dBm
• 470 - 862 MHz (BW = 100 kHz)			-54	dBm
• 862 - 1000 MHz (BW = 100 kHz)			-36	dBm
• 1000 - 5150 MHz (BW = 1 MHz)			-30	dBm
• 5350 - 5470 MHz (BW = 1 MHz)			-30	dBm

Items	Contents			
• 5725 - 26000 MHz (BW = 1 MHz)			-30	dBm
Rx Characteristics	Minimum	Typical	Maximum	Unit
Minimum Input Level (PER ≤ 10%)			-82	dBm
Maximum Input Level (PER < 10%)	-30			dBm
Adjacent Channel Rejection (PER ≤ 10%)	-1			dB

12.6 DC/RF Characteristics for IEEE 802.11n (HT20) - 5 GHz

Table 38: DC/RF Characteristics for IEEE 802.11n (HT20) - 5 GHz

Items	Contents
Specification	IEEE 802.11n
Mode	OFDM
Channel Frequency	5180 to 5240 MHz 5260 to 5320 MHz 5500 to 5720 MHz 5745 to 5825 MHz
Data rate	MCS0 - MCS7

12.6.1 High-Rate Condition for IEEE 802.11n (HT20) - 5 GHz

Conditions: 25 °C, VDD33 = 3.3V, VDD18 = 1.8V VIO = 1.8V, Output power setting = 16 dBm, MCS7 mode

Table 39: High-Rate Condition for IEEE 802.11n (HT20) - 5 GHz

Items	Contents			
DC Characteristics	Minimum	Typical	Maximum	Unit
DC current				
• Tx mode	VDD18	400		mA
	VDD33	240		mA
	VDD18 (MIMO)	620		mA
	VDD33 (MIMO)	450		mA
• Rx mode	VDD18	320		mA
	VDD33	0.2		mA
	VDD18 (MIMO)	320		mA
	VDD33 (MIMO)	0.2		mA
Tx Characteristics	Minimum	Typical	Maximum	Unit
Output Power	14	16	18	dBm
Spectrum Mask Margin				
• 9 MHz to 11 MHz (0 ~ -20 dBr)	0			dB
• 11 MHz to 20 MHz (-20 ~ -28 dBr)	0			dB
• 20 MHz to 30 MHz (-28 ~ -45 dBr)	0			dB
• 30 MHz to 33 MHz (-45 dBr)	0			dB
Constellation Error (EVM) (Measured at enhanced mode)			-27	dB

Items	Contents			
Frequency Tolerance	-20		20	ppm
Spurious Emissions				
• 30 - 47 MHz (BW = 100 kHz)			-36	dBm
• 47 - 74 MHz (BW = 100 kHz)			-54	dBm
• 74 - 87.5 MHz (BW = 100 kHz)			-36	dBm
• 87.5 - 118 MHz (BW = 100 kHz)			-54	dBm
• 118 - 174 MHz (BW = 100 kHz)			-36	dBm
• 174 - 230 MHz (BW = 100 kHz)			-54	dBm
• 230 - 470 MHz (BW = 100 kHz)			-36	dBm
• 470 - 862 MHz (BW = 100 kHz)			-54	dBm
• 862 - 1000 MHz (BW = 100 kHz)			-36	dBm
• 1000 - 5150 MHz (BW = 1 MHz)			-30	dBm
• 5350 - 5470 MHz (BW = 1 MHz)			-30	dBm
• 5725 - 26000 MHz (BW = 1 MHz)			-30	dBm
Rx Characteristics	Minimum	Typical	Maximum	Unit
Minimum Input Level (PER ≤ 10%)			-64	dBm
Maximum Input Level (PER < 10%)	-30			dBm
Adjacent Channel Rejection (PER ≤ 10%)	-2			dB

12.6.2 Low-Rate Condition for IEEE 802.11n (HT20) - 5 GHz

Conditions: 25 °C, VDD33 = 3.3V, VDD18 = 1.8V VIO = 1.8V, Output power setting = 16 dBm, MCS0 mode

Table 40: Low-Rate Condition for IEEE 802.11n (HT20) - 5 GHz

Items	Contents			
DC Characteristics	Minimum	Typical	Maximum	Unit
DC current				
• Tx mode	VDD18	400		mA
	VDD33	250		mA
	VDD18 (MIMO)	630		mA
	VDD33 (MIMO)	470		mA
• Rx mode	VDD18	320		mA
	VDD33	0.2		mA
	VDD18 (MIMO)	320		mA
	VDD33 (MIMO)	0.2		mA
Tx Characteristics	Minimum	Typical	Maximum	Unit
Output Power	14	16	18	dBm
Spectrum Mask Margin				
• 9 MHz to 11 MHz (0 ~ -20 dBr)	0			dB
• 11 MHz to 20 MHz (-20 ~ -28 dBr)	0			dB
• 20 MHz to 30 MHz (-28 ~ -45 dBr)	0			dB
• 30 MHz to 33 MHz (-45 dBr)	0			dB
Constellation Error (EVM) (Measured at enhanced mode)			-27	dB
Frequency Tolerance	-20		20	ppm
Spurious Emissions				
• 30-47 MHz (BW = 100 kHz)			-36	dBm

Items	Contents			
• 47 - 74 MHz (BW = 100 kHz)			-54	dBm
• 74 - 87.5 MHz (BW = 100 kHz)			-36	dBm
• 87.5 - 118 MHz (BW = 100 kHz)			-54	dBm
• 118 - 174 MHz (BW = 100 kHz)			-36	dBm
• 174 - 230 MHz (BW = 100 kHz)			-54	dBm
• 230 - 470 MHz (BW = 100 kHz)			-36	dBm
• 470 - 862 MHz (BW = 100 kHz)			-54	dBm
• 862 - 1000 MHz (BW = 100 kHz)			-36	dBm
• 1000 - 5150 MHz (BW = 1 MHz)			-30	dBm
• 5350 - 5470 MHz (BW = 1 MHz)			-30	dBm
• 5725 - 26000 MHz (BW = 1 MHz)			-30	dBm
Rx Characteristics	Minimum	Typical	Maximum	Unit
Minimum Input Level (PER ≤ 10%)			-82	dBm
Maximum Input Level (PER < 10%)	-30			dBm
Adjacent Channel Rejection (PER ≤ 10%)	-2			dB

12.7 DC/RF Characteristics for IEEE 802.11ac (VHT20) - 5 GHz

Table 41: DC/RF Characteristics for IEEE 802.11ac (VHT20) - 5 GHz

Items	Contents
Specification	IEEE 802.11ac
Mode	OFDM
Channel Frequency	5180 to 5240 MHz 5260 to 5320 MHz 5500 to 5720 MHz 5745 to 5825 MHz
Data rate	MCS0 - MCS8

12.7.1 High-Rate Condition for IEEE 802.11ac (VHT20) - 5 GHz

Conditions: 25 °C, VDD33 = 3.3V, VDD18 = 1.8V, VIO = 1.8V, Output power setting = 15 dBm, MCS8 mode

Table 42: High-Rate Condition for IEEE 802.11ac (VHT20) - 5 GHz

Items	Contents			
DC Characteristics	Minimum	Typical	Maximum	Unit
DC current				
• Tx mode	VDD18	370		mA
	VDD33	220		mA
	VDD18 (MIMO)	560		mA
	VDD33 (MIMO)	420		mA
• Rx mode	VDD18	320		mA
	VDD33	0.2		mA
	VDD18 (MIMO)	320		mA
	VDD33 (MIMO)	0.2		mA
Tx Characteristics	Minimum	Typical	Maximum	Unit
Output Power	13	15	17	dBm
Spectrum Mask Margin				
• 9 MHz to 11 MHz (0 ~ -20 dBr)	0			dB
• 11 MHz to 20 MHz (-20 ~ -28 dBr)	0			dB
• 20 MHz to 30 MHz (-28 ~ -40 dBr)	0			dB
• 30 MHz to 33 MHz (-40 dBr)	0			dB
Constellation Error (EVM) (Measured at enhanced mode)			-30	dB
Frequency Tolerance	-20		20	ppm
Spurious Emissions				
• 30 - 47 MHz (BW = 100 kHz)			-36	dBm
• 47 - 74 MHz (BW = 100 kHz)			-54	dBm
• 74 - 87.5 MHz (BW = 100 kHz)			-36	dBm
• 87.5 - 118 MHz (BW = 100 kHz)			-54	dBm
• 118 - 174 MHz (BW = 100 kHz)			-36	dBm
• 174 - 230 MHz (BW = 100 kHz)			-54	dBm
• 230 - 470 MHz (BW = 100 kHz)			-36	dBm
• 470 - 862 MHz (BW = 100 kHz)			-54	dBm
• 862 - 1000 MHz (BW = 100 kHz)			-36	dBm
• 1000 - 5150 MHz (BW = 1 MHz)			-30	dBm
• 5350 - 5470 MHz (BW = 1 MHz)			-30	dBm
• 5725 - 26000 MHz (BW = 1 MHz)			-30	dBm
Rx Characteristics	Minimum	Typical	Maximum	Unit
Minimum Input Level (PER ≤ 10%)			-59	dBm
Maximum Input Level (PER < 10%)	-30			dBm
Adjacent Channel Rejection (PER ≤ 10%)	-7			dB

12.7.2 Low-Rate Condition for IEEE 802.11ac (VHT20) - 5 GHz

Conditions: 25 °C, VDD33 = 3.3V, VDD18 = 1.8V, VIO = 1.8V, Output power setting = 16 dBm, MCS0 mode

Table 43: Low-Rate Condition for IEEE 802.11ac (VHT20) - 5 GHz

Items		Contents			
DC Characteristics		Minimum	Typical	Maximum	Unit
DC current					
• Tx mode	VDD18		400		mA
	VDD33		250		mA
	VDD18 (MIMO)		640		mA
	VDD33 (MIMO)		470		mA
• Rx mode	VDD18		320		mA
	VDD33		0.2		mA
	VDD18 (MIMO)		320		mA
	VDD33 (MIMO)		0.2		mA
Tx Characteristics		Minimum	Typical	Maximum	Unit
Output Power		14	16	18	dBm
Spectrum Mask Margin					
•	9 MHz to 11 MHz (0 ~ -20 dBr)	0			dB
•	11 MHz to 20 MHz (-20 ~ -28 dBr)	0			dB
•	20 MHz to 30 MHz (-28 ~ --40 dBr)	0			dB
•	30 MHz to 33 MHz (--40 dBr)	0			dB
Constellation Error (EVM) (Measured at enhanced mode)				-30	dB
Frequency Tolerance		-20		20	ppm
Spurious Emissions					
•	30 - 47 MHz (BW = 100 kHz)			-36	dBm
•	47 - 74 MHz (BW = 100 kHz)			-54	dBm
•	74 - 87.5 MHz (BW = 100 kHz)			-36	dBm
•	87.5 - 118 MHz (BW = 100 kHz)			-54	dBm
•	118 - 174 MHz (BW = 100 kHz)			-36	dBm
•	174 - 230 MHz (BW = 100 kHz)			-54	dBm
•	230 - 470 MHz (BW = 100 kHz)			-36	dBm
•	470 - 862 MHz (BW = 100 kHz)			-54	dBm
•	862 - 1000 MHz (BW = 100 kHz)			-36	dBm
•	1000 - 5150 MHz (BW = 1 MHz)			-30	dBm
•	5350 - 5470 MHz (BW = 1 MHz)			-30	dBm
•	5725 - 26000 MHz (BW = 1 MHz)			-30	dBm
Rx Characteristics		Minimum	Typical	Maximum	Unit
Minimum Input Level (PER ≤ 10%)				-82	dBm
Maximum Input Level (PER < 10%)		-30			dBm
Adjacent Channel Rejection (PER ≤ 10%)		-7			dB

12.8 DC/RF Characteristics for IEEE 802.11n (HT40) - 5 GHz

Table 44: DC/RF Characteristics for IEEE 802.11n (HT40) - 5 GHz

Items	Contents
Specification	IEEE 802.11n
Mode	OFDM
Channel Frequency	5190 to 5795 MHz
Data rate	MCS0 - MCS7

12.8.1 High-Rate Condition for IEEE 802.11n (HT40) - 5 GHz

Conditions: 25 °C, VDD33 = 3.3V, VDD18 = 1.8V VIO = 1.8V, Output power setting = 16 dBm MCS7 mode

Table 45: High-Rate Condition for IEEE 802.11n (HT40) - 5 GHz

Items	Contents			
	Minimum	Typical	Maximum	Unit
DC Characteristics				
DC current				
• Tx mode	VDD18	410		mA
	VDD33	240		mA
	VDD18 (MIMO)	630		mA
	VDD33 (MIMO)	440		mA
• Rx mode	VDD18	320		mA
	VDD33	0.2		mA
	VDD18 (MIMO)	350		mA
	VDD33 (MIMO)	0.2		mA
Tx Characteristics				
Output Power	14	16	18	dBm
Spectrum Mask Margin				
• 19 MHz to 21 MHz (0 ~ -20 dBr)	0			dB
• 21 MHz to 40 MHz (-20 ~ -28 dBr)	0			dB
• 40 MHz to 60 MHz (-28 ~ -45 dBr)	0			dB
• 60 MHz to 80 MHz (-45 dBr)	0			dB
Constellation Error (EVM) (Measured at enhanced mode)			-27	dB
Frequency Tolerance	-20		20	ppm
Spurious Emissions				
• 30 - 47 MHz (BW = 100 kHz)			-36	dBm
• 47 - 74 MHz (BW = 100 kHz)			-54	dBm
• 74 - 87.5 MHz (BW = 100 kHz)			-36	dBm
• 87.5 - 118 MHz (BW = 100 kHz)			-54	dBm
• 118 - 174 MHz (BW = 100 kHz)			-36	dBm
• 174 - 230 MHz (BW = 100 kHz)			-54	dBm
• 230 - 470 MHz (BW = 100 kHz)			-36	dBm
• 470 - 862 MHz (BW = 100 kHz)			-54	dBm
• 862 - 1000 MHz (BW = 100 kHz)			-36	dBm

Items	Contents			
• 1000 - 5150 MHz (BW = 1 MHz)			-30	dBm
• 5350 - 5470 MHz (BW = 1 MHz)			-30	dBm
• 5725 - 26000 MHz (BW = 1 MHz)			-30	dBm
Rx Characteristics	Minimum	Typical	Maximum	Unit
Minimum Input Level (PER ≤ 10%)			-61	dBm
Maximum Input Level (PER ≤ 10%)	-30			dBm
Adjacent Channel Rejection (PER ≤ 10%)	-2			dB

12.8.2 Low-Rate Condition for IEEE 802.11n (HT40) - 5 GHz

Conditions: 25 °C, VDD33 = 3.3V, VDD18 = 1.8V, VIO = 1.8V, Output power setting = 16 dBm, MCS0 mode

Table 46: Low-Rate Condition for IEEE 802.11n (HT40) - 5 GHz

Items	Contents			
DC Characteristics -	Minimum	Typical	Maximum	Unit
DC current				
• Tx mode	VDD18	410		mA
	VDD33	250		mA
	VDD18 (MIMO)	650		mA
	VDD33 (MIMO)	470		mA
• Rx mode	VDD18	320		mA
	VDD33	0.2		mA
	VDD18 (MIMO)	350		mA
	VDD33 (MIMO)	0.2		mA
Tx Characteristics	Minimum	Typical	Maximum	Unit
Output Power	14	16	18	dBm
Spectrum Mask Margin				
• 19 MHz to 21 MHz (0 ~ -20 dBr)	0			dB
• 21 MHz to 40 MHz (-20 ~ -28 dBr)	0			dB
• 40 MHz to 60 MHz (-28 ~ -45 dBr)	0			dB
• 60 MHz to 80 MHz (-45 dBr)	0			dB
Constellation Error (EVM) (Measured at enhanced mode)			-27	dB
Frequency Tolerance	-20		20	ppm
Spurious Emissions				
• 30 - 47 MHz (BW = 100 kHz)			-36	dBm
• 47 - 74 MHz (BW = 100 kHz)			-54	dBm
• 74 - 87.5 MHz (BW = 100 kHz)			-36	dBm
• 87.5 - 118 MHz (BW = 100 kHz)			-54	dBm
• 118 - 174 MHz (BW = 100 kHz)			-36	dBm
• 174 - 230 MHz (BW = 100 kHz)			-54	dBm
• 230 - 470 MHz (BW = 100 kHz)			-36	dBm
• 470 - 862 MHz (BW = 100 kHz)			-54	dBm
• 862 - 1000 MHz (BW = 100 kHz)			-36	dBm
• 1000 - 5150 MHz (BW = 1 MHz)			-30	dBm
• 5350 - 5470 MHz (BW = 1 MHz)			-30	dBm
• 5725 - 26000 MHz (BW = 1 MHz)			-30	dBm

Items	Contents			
	Minimum	Typical	Maximum	Unit
Rx Characteristics				
Minimum Input Level (PER ≤ 10%)			-79	dBm
Maximum Input Level (PER ≤ 10%)	-30			dBm
Adjacent Channel Rejection (PER ≤ 10%)	-2			dB

12.9 DC/RF Characteristics for IEEE 802.11ac (VHT40) - 5 GHz

Table 47: DC/RF Characteristics for IEEE 802.11ac (VHT40) - 5 GHz

Items	Contents
Specification	IEEE 802.11ac
Mode	OFDM
Channel Frequency	5190 to 5795 MHz
Data rate	MCS0 - MCS9

12.9.1 High-Rate Condition for IEEE 802.11ac (VHT40) - 5 GHz

Conditions: 25 °C, VDD33 = 3.3V, VDD18 = 1.8V, VIO = 1.8V, Output power setting = 15 dBm, MCS9 mode

Table 48: High-Rate Condition for IEEE 802.11ac (VHT40) - 5 GHz

Items	Contents			
	Minimum	Typical	Maximum	Unit
DC Characteristics				
DC current				
• Tx mode	VDD18	380		mA
	VDD33	210		mA
	VDD18 (MIMO)	570		mA
	VDD33 (MIMO)	410		mA
• Rx mode	VDD18	320		mA
	VDD33	0.2		mA
	VDD18 (MIMO)	350		mA
	VDD33 (MIMO)	0.2		mA
Tx Characteristics	Minimum	Typical	Maximum	Unit
Output Power	13	15	17	dBm
Spectrum Mask Margin				
• 19 MHz to 21 MHz (0 ~ -20 dBr)	0			dB
• 21 MHz to 40 MHz (-20 ~ -28 dBr)	0			dB
• 40 MHz to 60 MHz (-28 ~ -40 dBr)	0			dB
• 60 MHz to 80 MHz (-40 dBr)	0			dB
Constellation Error (EVM) (Measured at enhanced mode)			-32	dB
Frequency tolerance	-20		20	ppm
Spurious Emissions				
• 30 - 47 MHz (BW = 100 kHz)			-36	dBm
• 47 - 74 MHz (BW = 100 kHz)			-54	dBm

Items	Contents			
• 74 - 87.5 MHz (BW = 100 kHz)			-36	dBm
• 87.5 - 118 MHz (BW = 100 kHz)			-54	dBm
• 118 - 174 MHz (BW = 100 kHz)			-36	dBm
• 174 - 230 MHz (BW = 100 kHz)			-54	dBm
• 230 - 470 MHz (BW = 100 kHz)			-36	dBm
• 470 - 862 MHz (BW = 100 kHz)			-54	dBm
• 862 - 1000 MHz (BW = 100 kHz)			-36	dBm
• 1000 - 5150 MHz (BW = 1 MHz)			-30	dBm
• 5350 - 5470 MHz (BW = 1 MHz)			-30	dBm
• 5725 - 26000 MHz (BW = 1 MHz)			-30	dBm
Rx Characteristics	Minimum	Typical	Maximum	Unit
Minimum Input Level (PER ≤ 10%)			-54	dBm
Maximum Input Level (PER ≤ 10%)	-30			dBm
Adjacent Channel Rejection (PER ≤ 10%)	-9			dB

12.9.2 Low-Rate Condition for IEEE 802.11ac (VHT40) - 5 GHz

Conditions: 25 °C, VDD33 = 3.3V, VDD18 = 1.8V, VIO = 1.8V, Output power setting = 16 dBm, MCS0 mode

Table 49: Low-Rate Condition for IEEE 802.11ac (VHT40) - 5 GHz

Items	Contents			
DC Characteristics	Minimum	Typical	Maximum	Unit
DC current				
• Tx mode	VDD18	410		mA
	VDD33	250		mA
	VDD18 (MIMO)	650		mA
	VDD33 (MIMO)	470		mA
• Rx mode	VDD18	320		mA
	VDD33	0.2		mA
	VDD18 (MIMO)	350		mA
	VDD33 (MIMO)	0.2		mA
Tx Characteristics	Minimum	Typical	Maximum	Unit
Output Power	14	16	18	dBm
Spectrum Mask Margin				
• 19 MHz to 21 MHz (0 ~ -20 dBr)	0			dB
• 21 MHz to 40 MHz (-20 ~ -28 dBr)	0			dB
• 40 MHz to 60 MHz (-28 ~ -40 dBr)	0			dB
• 60 MHz to 80 MHz (-40 dBr)	0			dB
Constellation Error (EVM) (Measured at enhanced mode)			-32	dB
Frequency Tolerance	-20		20	ppm
Spurious Emissions				
• 30 - 47 MHz (BW=100 kHz)			-36	dBm
• 47 - 74 MHz (BW=100 kHz)			-54	dBm
• 74 - 87.5 MHz (BW = 100 kHz)			-36	dBm
• 87.5 - 118 MHz (BW = 100 kHz)			-54	dBm

Items	Contents			
• 118 - 174 MHz (BW = 100 kHz)			-36	dBm
• 174 - 230 MHz (BW = 100 kHz)			-54	dBm
• 230 - 470 MHz (BW = 100 kHz)			-36	dBm
• 470 - 862 MHz (BW = 100 kHz)			-54	dBm
• 862 - 1000 MHz (BW = 100 kHz)			-36	dBm
• 1000 - 5150 MHz (BW = 1 MHz)			-30	dBm
• 5350 - 5470 MHz (BW = 1 MHz)			-30	dBm
• 5725 - 26000 MHz (BW = 1 MHz)			-30	dBm
Rx Characteristics	Minimum	Typical	Maximum	Unit
Minimum Input Level (PER ≤ 10%)			-79	dBm
Maximum Input Level (PER ≤ 10%)	-30			dBm
Adjacent Channel Rejection (PER ≤ 10%)	-9			dB

12.10 DC/RF Characteristics for IEEE 802.11ac (VHT80) - 5 GHz

Table 50: DC/RF Characteristics for IEEE 802.11ac (VHT80) - 5 GHz

Items	Contents
Specification	IEEE 802.11ac
Mode	OFDM
Channel Frequency	5210 to 5775 MHz
Data rate	MCS0 - MCS9

12.10.1 High-Rate Condition for IEEE 802.11ac (VHT80) - 5 GHz

Conditions: 25 °C, VDD33 = 3.3V, VDD18 = 1.8V, VIO = 1.8V, Output power setting = 14 dBm, MCS9 mode

Table 51: High-Rate Condition for IEEE 802.11ac (VHT80) - 5 GHz

Items	Contents			
DC Characteristics	Minimum	Typical	Maximum	Unit
DC current				
• Tx mode	VDD18		400	mA
	VDD33		200	mA
	VDD18 (MIMO)		600	mA
	VDD33 (MIMO)		380	mA
• Rx mode	VDD18		350	mA
	VDD33		0.2	mA
	VDD18 (MIMO)		420	mA
	VDD33 (MIMO)		0.2	mA
Tx Characteristics	Minimum	Typical	Maximum	Unit
Output Power	12	14	16	dBm
Spectrum Mask Margin				
• 39 MHz to 41 MHz (0 ~ -20 dBr)	0			dB

Items	Contents			
• 41 MHz to 80 MHz (-20 ~ -28 dBr)	0			dB
• 80 MHz to 120 MHz (-28 ~ -40 dBr)	0			dB
• 120 MHz to 140 MHz (-40 dBr)	0			dB
Constellation Error (EVM) (Measured at enhanced mode)			-32	dB
Frequency Tolerance	-20		20	ppm
Spurious Emissions				
• 30 - 47 MHz (BW = 100 kHz)			-36	dBm
• 47 - 74 MHz (BW = 100 kHz)			-54	dBm
• 74 - 87.5 MHz (BW = 100 kHz)			-36	dBm
• 87.5 - 118 MHz (BW = 100 kHz)			-54	dBm
• 118 - 174 MHz (BW = 100 kHz)			-36	dBm
• 174 - 230 MHz (BW = 100 kHz)			-54	dBm
• 230 - 470 MHz (BW = 100 kHz)			-36	dBm
• 470 - 862 MHz (BW = 100 kHz)			-54	dBm
• 862 - 1000 MHz (BW = 100 kHz)			-36	dBm
• 1000 - 5150 MHz (BW = 1 MHz)			-30	dBm
• 5350 - 5470 MHz (BW = 1 MHz)			-30	dBm
• 5725 - 26000 MHz (BW = 1 MHz)			-30	dBm
Rx Characteristics	Minimum	Typical	Maximum	Unit
Minimum Input Level (PER ≤ 10%)			-51	dBm
Maximum Input Level (PER ≤ 10%)	-30			dBm
Adjacent Channel Rejection (PER ≤ 10%)	-9			dB

12.10.2 Low-Rate Condition for IEEE 802.11ac (VHT80) - 5 GHz

Conditions: 25 °C, VDD33 = 3.3V, VDD18 = 1.8V, VIO = 1.8V, Output power setting = 15 dBm, MCS0 mode

Table 52: Low-Rate Condition for IEEE 802.11ac (VHT80) - 5 GHz

Items	Contents			
DC Characteristics	Minimum	Typical	Maximum	Unit
DC current				
• Tx mode	VDD18	400		mA
	VDD33	230		mA
	VDD18 (MIMO)	630		mA
	VDD33 (MIMO)	440		mA
• Rx mode	VDD18	350		mA
	VDD33	0.2		mA
	VDD18 (MIMO)	420		mA
	VDD33 (MIMO)	0.2		mA
Tx Characteristics	Minimum	Typical	Maximum	Unit
Output Power	13	15	17	dBm
Spectrum Mask Margin				
• 39 MHz to 41 MHz (0 ~ -20 dBr)	0			dB
• 41 MHz to 80 MHz (-20 ~ -28 dBr)	0			dB
• 80 MHz to 120 MHz (-28 ~ -40 dBr)	0			dB
• 120 MHz to 140 MHz (-40 dBr)	0			dB

Items	Contents			
Constellation Error (EVM) (Measured at enhanced mode)			-19	dB
Frequency Tolerance	-20		20	ppm
Spurious Emissions				
• 30 - 47 MHz (BW = 100 kHz)			-36	dBm
• 47 - 74 MHz (BW = 100 kHz)			-54	dBm
• 74 - 87.5 MHz (BW = 100 kHz)			-36	dBm
• 87.5 - 118 MHz (BW = 100 kHz)			-54	dBm
• 118 - 174 MHz (BW = 100 kHz)			-36	dBm
• 174 - 230 MHz (BW = 100 kHz)			-54	dBm
• 230 - 470 MHz (BW = 100 kHz)			-36	dBm
• 470 - 862 MHz (BW = 100 kHz)			-54	dBm
• 862 - 1000 MHz (BW = 100 kHz)			-36	dBm
• 1000 - 5150 MHz (BW = 1 MHz)			-30	dBm
• 5350 - 5470 MHz (BW = 1 MHz)			-30	dBm
• 5725 - 26000 MHz (BW = 1 MHz)			-30	dBm
Rx Characteristics	Minimum	Typical	Maximum	Unit
Minimum Input Level (PER ≤ 10%)			-76	dBm
Maximum Input Level (PER ≤ 10%)	-30			dBm
Adjacent Channel Rejection (PER ≤ 10%)	-9			dB

12.11 DC/RF Characteristics for IEEE 802.11ax (HE20) - 5 GHz

Table 53: DC/RF Characteristics for IEEE 802.11ax (HE20) - 5 GHz

Items	Contents
Specification	IEEE 802.11ax
Mode	OFDM
Channel Frequency	5180 to 5240 MHz 5260 to 5320 MHz 5500 to 5720 MHz 5745 to 5825 MHz
Data rate	MCS0 - MCS11

12.11.1 High-Rate Condition for IEEE 802.11ax (HE20) - 5 GHz

Conditions: 25 °C, VDD33 = 3.3V, VDD18 = 1.8V, VIO = 1.8V, Output power setting =14 dBm, MCS11 mode

Table 54: High-Rate Condition for IEEE 802.11ax (HE20) - 5 GHz

Items		Contents			
DC Characteristics		Minimum	Typical	Maximum	Unit
DC current					
• Tx mode	VDD18		380		mA
	VDD33		210		mA
	VDD18 (MIMO)		560		mA
	VDD33 (MIMO)		400		mA
• Rx mode	VDD18		320		mA
	VDD33		0.2		mA
	VDD18 (MIMO)		320		mA
	VDD33 (MIMO)		0.2		mA
Tx Characteristics		Minimum	Typical	Maximum	Unit
Output Power		12	14	16	dBm
Spectrum Mask Margin					
• 39 MHz to 41 MHz (0 ~ -20 dBr)		0			dB
• 41 MHz to 80 MHz (-20 ~ -28 dBr)		0			dB
• 80 MHz to 120 MHz (-28 ~ -40 dBr)		0			dB
• 120 MHz to 140 MHz (-40 dBr)		0			dB
Constellation Error (EVM) (Measured at enhanced mode)				-32	dB
Frequency Tolerance		-20		20	ppm
Spurious Emissions					
• 30 - 47 MHz (BW = 100 kHz)				-36	dBm
• 47 - 74 MHz (BW = 100 kHz)				-54	dBm
• 74 - 87.5 MHz (BW = 100 kHz)				-36	dBm
• 87.5 - 118 MHz (BW = 100 kHz)				-54	dBm
• 118 - 174 MHz (BW = 100 kHz)				-36	dBm
• 174 - 230 MHz (BW = 100 kHz)				-54	dBm
• 230 - 470 MHz (BW = 100 kHz)				-36	dBm
• 470 - 862 MHz (BW = 100 kHz)				-54	dBm
• 862 - 1000 MHz (BW = 100 kHz)				-36	dBm
• 1000 - 5150 MHz (BW = 1 MHz)				-30	dBm
• 5350 - 5470 MHz (BW = 1 MHz)				-30	dBm
• 5725 - 26000 MHz (BW = 1 MHz)				-30	dBm
Rx Characteristics		Minimum	Typical	Maximum	Unit
Minimum Input Level (PER ≤ 10%)				-51	dBm
Maximum Input Level (PER ≤ 10%)		-30			dBm
Adjacent Channel Rejection (PER ≤ 10%)		-9			dB

12.11.2 Low-Rate Condition for IEEE 802.11ax (HE20) - 5 GHz

Conditions: 25 °C, VDD33 = 3.3V, VDD18 = 1.8V, VIO = 1.8V, Output power setting = 16 dBm, MCS0 mode

Table 55: Low-Rate Condition for IEEE 802.11ax (HE20) - 5 GHz

Items		Contents			
DC Characteristics		Minimum	Typical	Maximum	Unit
DC current					
• Tx mode	VDD18		400		mA
	VDD33		250		mA
	VDD18 (MIMO)		640		mA
	VDD33 (MIMO)		480		mA
• Rx mode	VDD18		320		mA
	VDD33		0.2		mA
	VDD18 (MIMO)		320		mA
	VDD33 (MIMO)		0.2		mA
Tx Characteristics		Minimum	Typical	Maximum	Unit
Output Power		14	16	18	dBm
Spectrum Mask Margin					
• 39 MHz to 41 MHz (0 ~ -20 dBr)		0			dB
• 41 MHz to 80 MHz (-20 ~ -28 dBr)		0			dB
• 80 MHz to 120 MHz (-28 ~ -40 dBr)		0			dB
• 120 MHz to 140 MHz (-40 dBr)		0			dB
Constellation Error (EVM) (Measured at enhanced mode)				-19	dB
Frequency Tolerance		-20		20	ppm
Spurious Emissions					
• 30 - 47 MHz (BW = 100 kHz)				-36	dBm
• 47 - 74 MHz (BW = 100 kHz)				-54	dBm
• 74 - 87.5 MHz (BW = 100 kHz)				-36	dBm
• 87.5 - 118 MHz (BW = 100 kHz)				-54	dBm
• 118 - 174 MHz (BW = 100 kHz)				-36	dBm
• 174 - 230 MHz (BW = 100 kHz)				-54	dBm
• 230 - 470 MHz (BW = 100 kHz)				-36	dBm
• 470 - 862 MHz (BW = 100 kHz)				-54	dBm
• 862 - 1000 MHz (BW = 100 kHz)				-36	dBm
• 1000 - 5150 MHz (BW = 1 MHz)				-30	dBm
• 5350 - 5470 MHz (BW = 1 MHz)				-30	dBm
• 5725 - 26000 MHz (BW = 1 MHz)				-30	dBm
Rx Characteristics		Minimum	Typical	Maximum	Unit
Minimum Input Level (PER ≤ 10%)				-76	dBm
Maximum Input Level (PER ≤ 10%)		-30			dBm
Adjacent Channel Rejection (PER ≤ 10%)		-9			dB

12.12 DC/RF Characteristics for IEEE 802.11ax (HE40) - 5 GHz

Table 56: DC/RF Characteristics for IEEE 802.11ax (HE40) - 5 GHz

Items	Contents
Specification	IEEE 802.11ax
Mode	OFDM
Channel Frequency	5210 to 5775 MHz
Data rate	MCS0 - MCS11

12.12.1 High-Rate Condition for IEEE 802.11ax (HE40) - 5 GHz

Conditions: 25 °C, VDD33 = 3.3V, VDD18 = 1.8V, VIO = 1.8V, Output power setting = 14 dBm, MCS11 mode

Table 57: High-Rate Condition for IEEE 802.11ax (HE40) - 5 GHz

Items		Contents			
DC Characteristics		Minimum	Typical	Maximum	Unit
DC current					
• Tx mode	VDD18		390		mA
	VDD33		210		mA
	VDD18 (MIMO)		560		mA
	VDD33 (MIMO)		400		mA
• Rx mode	VDD18		320		mA
	VDD33		0.2		mA
	VDD18 (MIMO)		350		mA
	VDD33 (MIMO)		0.2		mA
Tx Characteristics		Minimum	Typical	Maximum	Unit
Output Power		12	14	16	dBm
Spectrum Mask Margin					
• 39 MHz to 41 MHz (0 ~ -20 dBr)		0			dB
• 41 MHz to 80 MHz (-20 ~ -28 dBr)		0			dB
• 80 MHz to 120 MHz (-28 ~ -40 dBr)		0			dB
• 120 MHz to 140 MHz (-40 dBr)		0			dB
Constellation Error (EVM) (Measured at enhanced mode)				-32	dB
Frequency Tolerance		-20		20	ppm
Spurious Emissions					
• 30 - 47 MHz (BW = 100 kHz)				-36	dBm
• 47 - 74 MHz (BW = 100 kHz)				-54	dBm
• 74 - 87.5 MHz (BW = 100 kHz)				-36	dBm
• 87.5 - 118 MHz (BW = 100 kHz)				-54	dBm
• 118 - 174 MHz (BW = 100 kHz)				-36	dBm
• 174 - 230 MHz (BW = 100 kHz)				-54	dBm
• 230 - 470 MHz (BW = 100 kHz)				-36	dBm
• 470 - 862 MHz (BW = 100 kHz)				-54	dBm
• 862 - 1000 MHz (BW = 100 kHz)				-36	dBm

Items	Contents			
• 1000 - 5150 MHz (BW = 1 MHz)			-30	dBm
• 5350 - 5470 MHz (BW = 1 MHz)			-30	dBm
• 5725 - 26000 MHz (BW = 1 MHz)			-30	dBm
Rx Characteristics	Minimum	Typical	Maximum	Unit
Minimum Input Level (PER ≤ 10%)			-51	dBm
Maximum Input Level (PER ≤ 10%)	-30			dBm
Adjacent Channel Rejection (PER ≤ 10%)	-9			dB

12.12.2 Low-Rate Condition for IEEE 802.11ax (HE40) - 5 GHz

Conditions: 25 °C, VDD33 = 3.3V, VDD18 = 1.8V, VIO = 1.8V, Output power setting = 16 dBm, MCS0 mode

Table 58: Low-Rate Condition for IEEE 802.11ax (HE40) - 5 GHz

Items	Contents			
DC Characteristics	Minimum	Typical	Maximum	Unit
DC current				
• Tx mode	VDD18	420		mA
	VDD33	250		mA
	VDD18 (MIMO)	660		mA
	VDD33 (MIMO)	480		mA
• Rx mode	VDD18	320		mA
	VDD33	0.2		mA
	VDD18 (MIMO)	350		mA
	VDD33 (MIMO)	0.2		mA
Tx Characteristics	Minimum	Typical	Maximum	Unit
Output Power	14	16	18	dBm
Spectrum Mask Margin				
• 39 MHz to 41 MHz (0 ~ -20 dBr)	0			dB
• 41 MHz to 80 MHz (-20 ~ -28 dBr)	0			dB
• 80 MHz to 120 MHz (-28 ~ -40 dBr)	0			dB
• 120 MHz to 140 MHz (-40 dBr)	0			dB
Constellation Error (EVM) (Measured at enhanced mode)			-32	dB
Frequency Tolerance	-20		20	ppm
Spurious Emissions				
• 30 - 47 MHz (BW = 100 kHz)			-36	dBm
• 47 - 74 MHz (BW = 100 kHz)			-54	dBm
• 74 - 87.5 MHz (BW = 100 kHz)			-36	dBm
• 87.5 - 118 MHz (BW = 100 kHz)			-54	dBm
• 118 - 174 MHz (BW = 100 kHz)			-36	dBm
• 174 - 230 MHz (BW = 100 kHz)			-54	dBm
• 230 - 470 MHz (BW = 100 kHz)			-36	dBm
• 470 - 862 MHz (BW = 100 kHz)			-54	dBm
• 862 - 1000 MHz (BW = 100 kHz)			-36	dBm
• 1000 - 5150 MHz (BW = 1 MHz)			-30	dBm
• 5350 - 5470 MHz (BW = 1 MHz)			-30	dBm
• 5725 - 26000 MHz (BW = 1 MHz)			-30	dBm

Items	Contents			
	Minimum	Typical	Maximum	Unit
Rx Characteristics				
Minimum Input Level (PER ≤ 10%)			-76	dBm
Maximum Input Level (PER ≤ 10%)	-30			dBm
Adjacent Channel Rejection (PER ≤ 10%)	-9			dB

12.13 DC/RF Characteristics for IEEE 802.11ax (HE80) - 5 GHz

Table 59: DC/RF Characteristics for IEEE 802.11ax (HE80) - 5 GHz

Items	Contents
Specification	IEEE 802.11ax
Mode	OFDM
Channel Frequency	5210 to 5775 MHz
Data rate	MCS0 - MCS11

12.13.1 High-Rate Condition for IEEE 802.11ax (HE80) - 5 GHz

Conditions: 25 °C, VDD33 = 3.3V, VDD18 = 1.8V, VIO = 1.8V, Output power setting = 14 dBm, MCS11 mode

Table 60: High-Rate Condition for IEEE 802.11ax (HE80) - 5 GHz

Items	Contents			
	Minimum	Typical	Maximum	Unit
DC Characteristics				
DC current				
• Tx mode	VDD18	400		mA
	VDD33	200		mA
	VDD18 (MIMO)	600		mA
	VDD33 (MIMO)	400		mA
• Rx mode	VDD18	350		mA
	VDD33	0.2		mA
	VDD18 (MIMO)	420		mA
	VDD33 (MIMO)	0.2		mA
Tx Characteristics	Minimum	Typical	Maximum	Unit
Output Power	12	14	16	dBm
Spectrum Mask Margin				
• 39 MHz to 41 MHz (0 ~ -20 dBr)	0			dB
• 41 MHz to 80 MHz (-20 ~ -28 dBr)	0			dB
• 80 MHz to 120 MHz (-28 ~ -40 dBr)	0			dB
• 120 MHz to 140 MHz (-40 dBr)	0			dB
Constellation Error (EVM) (Measured at enhanced mode)			-32	dB
Frequency Tolerance	-20		20	ppm
Spurious Emissions				
• 30 - 47 MHz (BW = 100 kHz)			-36	dBm
• 47 - 74 MHz (BW = 100 kHz)			-54	dBm

Items	Contents			
• 74 - 87.5 MHz (BW = 100 kHz)			-36	dBm
• 87.5 - 118 MHz (BW = 100 kHz)			-54	dBm
• 118 - 174 MHz (BW = 100 kHz)			-36	dBm
• 174 - 230 MHz (BW = 100 kHz)			-54	dBm
• 230 - 470 MHz (BW = 100 kHz)			-36	dBm
• 470 - 862 MHz (BW = 100 kHz)			-54	dBm
• 862 - 1000 MHz (BW = 100 kHz)			-36	dBm
• 1000 - 5150 MHz (BW = 1 MHz)			-30	dBm
• 5350 - 5470 MHz (BW = 1 MHz)			-30	dBm
• 5725 - 26000 MHz (BW = 1 MHz)			-30	dBm
Rx Characteristics	Minimum	Typical	Maximum	Unit
Minimum Input Level (PER ≤ 10%)			-51	dBm
Maximum Input Level (PER ≤ 10%)	-30			dBm
Adjacent Channel Rejection (PER ≤ 10%)	-9			dB

12.13.2 Low-Rate Condition for IEEE 802.11ax (HE80) - 5 GHz

Conditions: 25 °C, VDD33 = 3.3V, VDD18 = 1.8V, VIO = 1.8V, Output power setting = 15 dBm, MCS0 mode

Table 61: Low-Rate Condition for IEEE 802.11ax (HE80) - 5 GHz

Items	Contents			
DC Characteristics	Minimum	Typical	Maximum	Unit
DC current				
• Tx mode	VDD18	400		mA
	VDD33	230		mA
	VDD18 (MIMO)	640		mA
	VDD33 (MIMO)	440		mA
• Rx mode	VDD18	350		mA
	VDD33	0.2		mA
	VDD18 (MIMO)	420		mA
	VDD33 (MIMO)	0.2		mA
Tx Characteristics	Minimum	Typical	Maximum	Unit
Output Power	13	15	17	dBm
Spectrum Mask Margin				
• 39 MHz to 41 MHz (0 ~ -20 dBr)	0			dB
• 41 MHz to 80 MHz (-20 ~ -28 dBr)	0			dB
• 80 MHz to 120 MHz (-28 ~ -40 dBr)	0			dB
• 120 MHz to 140 MHz (-40 dBr)	0			dB
Constellation Error (EVM) (Measured at enhanced mode)			-32	dB
Frequency Tolerance	-20		20	ppm
Spurious Emissions				
• 30 - 47 MHz (BW = 100 kHz)			-36	dBm
• 47 - 74 MHz (BW = 100 kHz)			-54	dBm
• 74 - 87.5 MHz (BW = 100 kHz)			-36	dBm
• 87.5 - 118 MHz (BW = 100 kHz)			-54	dBm
• 118 - 174 MHz (BW = 100 kHz)			-36	dBm

Items	Contents			
• 174 - 230 MHz (BW = 100 kHz)			-54	dBm
• 230 - 470 MHz (BW = 100 kHz)			-36	dBm
• 470 - 862 MHz (BW = 100 kHz)			-54	dBm
• 862 - 1000 MHz (BW = 100 kHz)			-36	dBm
• 1000 - 5150 MHz (BW = 1 MHz)			-30	dBm
• 5350 - 5470 MHz (BW = 1 MHz)			-30	dBm
• 5725 - 26000 MHz (BW = 1 MHz)			-30	dBm
Rx Characteristics	Minimum	Typical	Maximum	Unit
Minimum Input Level (PER ≤ 10%)			-76	dBm
Maximum Input Level (PER ≤ 10%)	-30			dBm
Adjacent Channel Rejection (PER ≤ 10%)	-9			dB

12.14 DC/RF Characteristics for Bluetooth

12.14.1 Basic Data Rate Condition

Conditions: 25 °C, VDD33 = 3.3V, VDD18 = 1.8V VIO = 1.8V

Table 62: Basic Data Rate Condition

Items	Contents			
Bluetooth specification (power class)	Version 5.3			
Channel frequency (spacing)	2402 to 2480 MHz (1 MHz)			
Current Consumption	Minimum	Typical	Maximum	Unit
• Tx mode DH5	VDD18	45		mA
	VDD33	0.2		mA
• Rx mode DH5	VDD18	20		mA
	VDD33	0.2		mA
Tx Characteristics	Minimum	Typical	Maximum	Unit
Output Power@DH5	0	3	6	dBm
Frequency range	2400		2483.5	MHz
20 dB bandwidth			1	MHz
Adjacent Channel Power ³				
• [M-N] = 2			-20	dBm
• [M-N] ≥ 3			-40	dBm
Modulation Characteristics				
• Modulation $\Delta f_{1\text{avg}}$	140	151	175	kHz
• Modulation $\Delta f_{2\text{max}}$	115			kHz
• Modulation $\Delta f_{2\text{avg}} / \Delta f_{1\text{avg}}$	0.8	1		
Carrier Frequency Drift				
• 1 slot	-25		25	kHz
• 3 slot / 5 slot	-40		40	kHz
• Maximum Drift Rate			20	kHz/50 μ s
Rx Characteristics	Minimum	Typical	Maximum	Unit

³ Up to three spurious responses within Bluetooth limits are allowed.

Items	Contents			
BDR Sensitivity (BER $\leq 0.1\%$)		-91	-86	dBm
C/I Performance (BER $\leq 0.1\%$) ⁴				
• co-channel			11	dB
• 1 MHz			0	dB
• 2 MHz			-30	dB
• 3 MHz			-40	dB
• image (+4 MHz)			-9	dB
• image +/- 1 MHz			-20	dB
Maximum Input Level (BER $\leq 0.1\%$)	-20			dBm

12.14.2 Enhanced Data Rate Condition

Conditions: 25 °C, VDD33 = 3.3V, VDD18 = 1.8V VIO = 1.8V

Table 63: Enhanced Data Rate Condition

Items	Contents			
Bluetooth Specification (power class)	Version 5.3			
Channel Frequency (spacing)	2402 to 2480 MHz (1 MHz)			
Current Consumption	Minimum	Typical	Maximum	Unit
• Tx mode 2DH5	VDD18	45		mA
	VDD33	0.2		mA
• Rx mode 2DH5	VDD18	20		mA
	VDD33	0.2		mA
• Tx mode 3DH5	VDD18	45		mA
	VDD33	0.2		mA
• Rx mode 3DH5	VDD18	20		mA
	VDD33	0.2		mA
Tx Characteristics	Minimum	Typical	Maximum	Unit
Output Power@2DH5/3DH5	-3	0	3	dBm
Frequency Range	2400		2483.5	MHz
20 dB bandwidth			1	MHz
Adjacent Channel Power ⁵				
• [M-N] = 2			-20	dBm
• [M-N] ≥ 3			-40	dBm
EDR Relative Power	-4		1	dB
EDR Carrier Frequency Stability and Modulation Accuracy				
• ω_i	-75		75	kHz
• $\omega_i + \omega_o$	-75		75	kHz
• ω_o	-10		10	kHz
• RMS DEVM (DQPSK)			20	%
• Peak DEVM (DQPSK)			35	%
• 99% DEVM (DQPSK)			30	%
• RMS DEVM (8DPSK)			13	%

⁴ Up to five spurious responses within Bluetooth limits are allowed.

⁵ Up to three spurious responses within Bluetooth limits are allowed.

Items	Contents			
• Peak DEVM (8DPSK)			25	%
• 99% DEVM (8DPSK)			20	%
Spurious Emissions				
• 30 - 47 MHz (BW = 100 kHz)			-36	dBm
• 47 - 74 MHz (BW = 100 kHz)			-54	dBm
• 74 - 87.5 MHz (BW = 100 kHz)			-36	dBm
• 87.5 - 118 MHz (BW = 100 kHz)			-54	dBm
• 118 - 174 MHz (BW = 100 kHz)			-36	dBm
• 174 - 230 MHz (BW = 100 kHz)			-54	dBm
• 230 - 470 MHz (BW = 100 kHz)			-36	dBm
• 470 - 862 MHz (BW = 100 kHz)			-54	dBm
• 862 - 1000 MHz (BW = 100 kHz)			-36	dBm
• 1000 - 12750 MHz (BW = 1 MHz)			-30	dBm
Rx Characteristics	Minimum	Typical	Maximum	Unit
EDR Sensitivity (BER ≤ 0.007%)@8DPSK		-88	-82	dBm
C/I Performance (BER ≤ 0.1%) ⁶				
• co-channel			11	dB
• 1 MHz			0	dB
• 2 MHz			-30	dB
• 3 MHz			-40	dB
• image (+4 MHz)			-9	dB
• image +/- 1 MHz			-20	dB
Maximum Input Level (BER ≤ 0.1%)	-20			dBm

12.15 DC/RF Characteristics for Bluetooth Low Energy

This section describes DC/RF characteristics for Bluetooth low energy.

12.15.1 1 Mbps PHY Condition

Conditions: 25 °C, VDD33 = 3.3V, VDD18 = 1.8V VIO = 1.8V

Table 64: 1 Mbps PHY Condition

Items	Contents			
Bluetooth Specification (power class)	Version 5.3			
Channel Frequency (spacing)	2402 to 2480 MHz (2 MHz)			
Number of RF Channel	40			
Current Consumption	Minimum	Typical	Maximum	Unit
• Tx mode	VDD18	60		mA
	VDD33	0.2		mA
• Rx mode	VDD18	20		mA
	VDD33	0.2		mA

⁶ Up to five spurious responses within Bluetooth limits are allowed.

Tx Characteristics	Minimum	Typical	Maximum	Unit
Center Frequency	2402		2480	MHz
Channel Spacing		2		MHz
Number of RF channel		40		-
Output power	0	3	6	dBm
Modulation Characteristics				
• $\Delta f_{1\text{avg}}$	225		275	kHz
• $\Delta f_{2\text{max}}$ (at 99.9%)	185			kHz
• $\Delta f_{2\text{avg}} / \Delta f_{1\text{avg}}$	0.8			
Carrier Frequency Offset and Drift				
• Frequency offset			150	kHz
• Frequency drift			50	kHz
• Drift rate			20	kHz
Spurious Emissions				
• 30 - 47 MHz (BW = 100 kHz)			-36	dBm
• 47 - 74 MHz (BW = 100 kHz)			-54	dBm
• 74 - 87.5 MHz (BW = 100 kHz)			-36	dBm
• 87.5 - 118 MHz (BW = 100 kHz)			-54	dBm
• 118 - 174 MHz (BW = 100 kHz)			-36	dBm
• 174 - 230 MHz (BW = 100 kHz)			-54	dBm
• 230 - 470 MHz (BW = 100 kHz)			-36	dBm
• 470 - 862 MHz (BW = 100 kHz)			-54	dBm
• 862 - 1000 MHz (BW = 100 kHz)			-36	dBm
• 1000 - 12750 MHz (BW = 1 MHz)			-30	dBm
Rx Characteristics	Minimum	Typical	Maximum	Unit
Receiver Sensitivity (PER < 30.8%)		-95	-90	dBm
Maximum Input Signal Level (PER < 30.8%)	-10			dBm
PER Report Integrity (-30 dBm input)	50		65.4	%

12.15.2 2 Mbps PHY Condition

Conditions: 25 °C, VDD33 = 3.3V, VDD18 = 1.8V VIO = 1.8V

Table 65: 2 Mbps PHY Condition

Items	Contents			
Bluetooth Specification (power class)	Version 5.3			
Channel Frequency (spacing)	2402 to 2480 MHz (2 MHz)			
Number of RF Channel	40			
Current Consumption	Minimum	Typical	Maximum	Unit
• Tx mode	VDD18	60		mA
	VDD33	0.2		mA
• Rx mode	VDD18	20		mA
	VDD33	0.2		mA
Tx Characteristics	Minimum	Typical	Maximum	Unit
Center Frequency	2402		2480	MHz
Channel Spacing		2		MHz

Number of RF channel		40		
Output Power	0	3	6	dBm
Modulation Characteristics				
• $\Delta f_{1\text{avg}}$	225		275	kHz
• $\Delta f_{2\text{max}}$ (at 99.9%)	185			kHz
• $\Delta f_{2\text{avg}} / \Delta f_{1\text{avg}}$	0.8			
Carrier frequency offset and drift				
• Frequency Offset			150	kHz
• Frequency Drift			50	kHz
• Drift Rate			20	kHz
Spurious Emissions				
• 30 - 47 MHz (BW = 100 kHz)			-36	dBm
• 47 - 74 MHz (BW = 100 kHz)			-54	dBm
• 74 - 87.5 MHz (BW = 100 kHz)			-36	dBm
• 87.5 - 118 MHz (BW = 100 kHz)			-54	dBm
• 118 - 174 MHz (BW = 100 kHz)			-36	dBm
• 174 - 230 MHz (BW = 100 kHz)			-54	dBm
• 230 - 470 MHz (BW = 100 kHz)			-36	dBm
• 470 - 862 MHz (BW = 100 kHz)			-54	dBm
• 862 - 1000 MHz (BW = 100 kHz)			-36	dBm
• 1000 - 12750 MHz (BW = 1 MHz)			-30	dBm
Rx Characteristics	Minimum	Typical	Maximum	Unit
Receiver sensitivity (PER < 30.8%)		-95	-90	dBm
Maximum input signal level (PER < 30.8%)	-10			dBm
PER Report Integrity (-30 dBm input)	50		65.4	%

13 Land Patterns

The recommended land pattern is shown in **Figure 16**.

Figure 16: Land Patterns (Unit: mm)

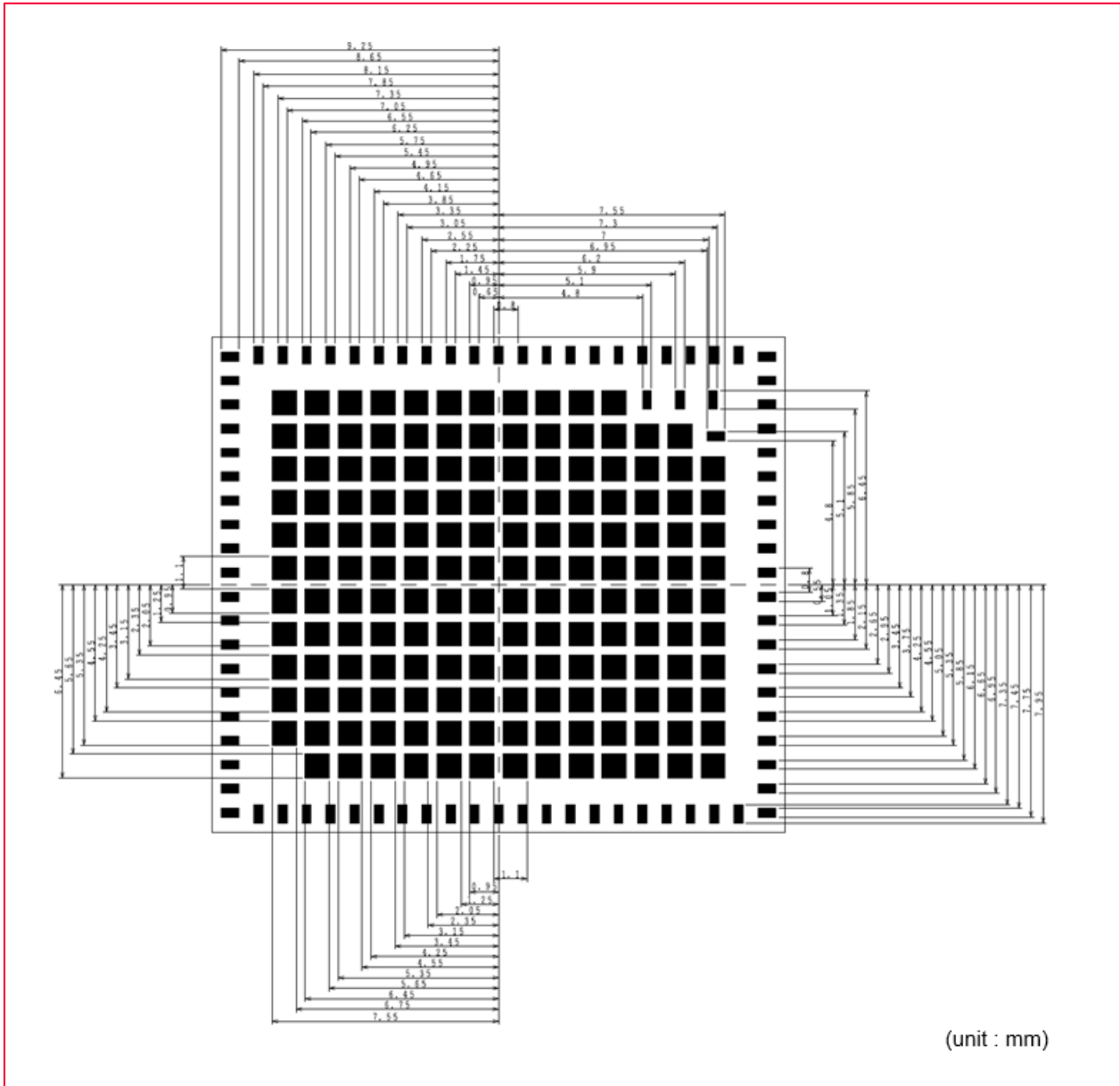

14.2 Dimensions of Reel

Figure 18 shows the reel dimensions.

Figure 18: Dimensions of Reel (Unit: mm)

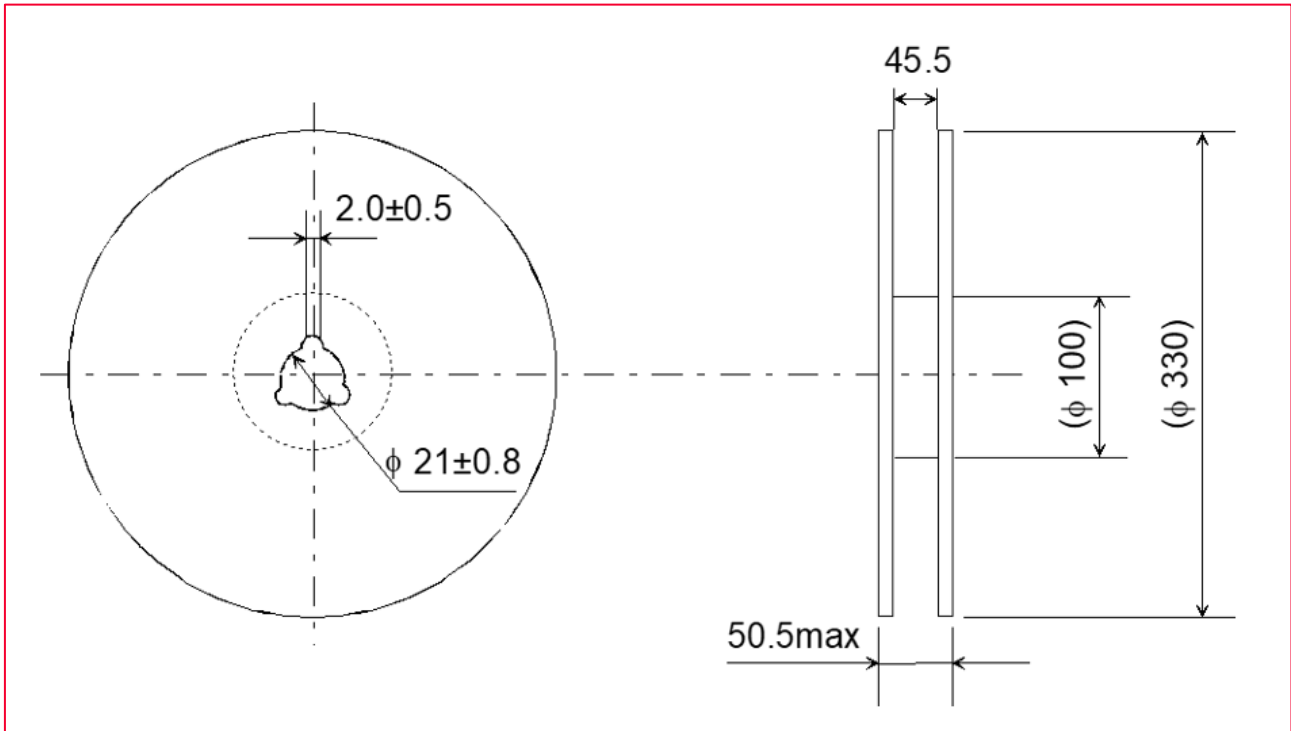

14.3 Taping Diagrams

Figure 19 shows the taping diagrams.

Figure 19: Taping Diagrams

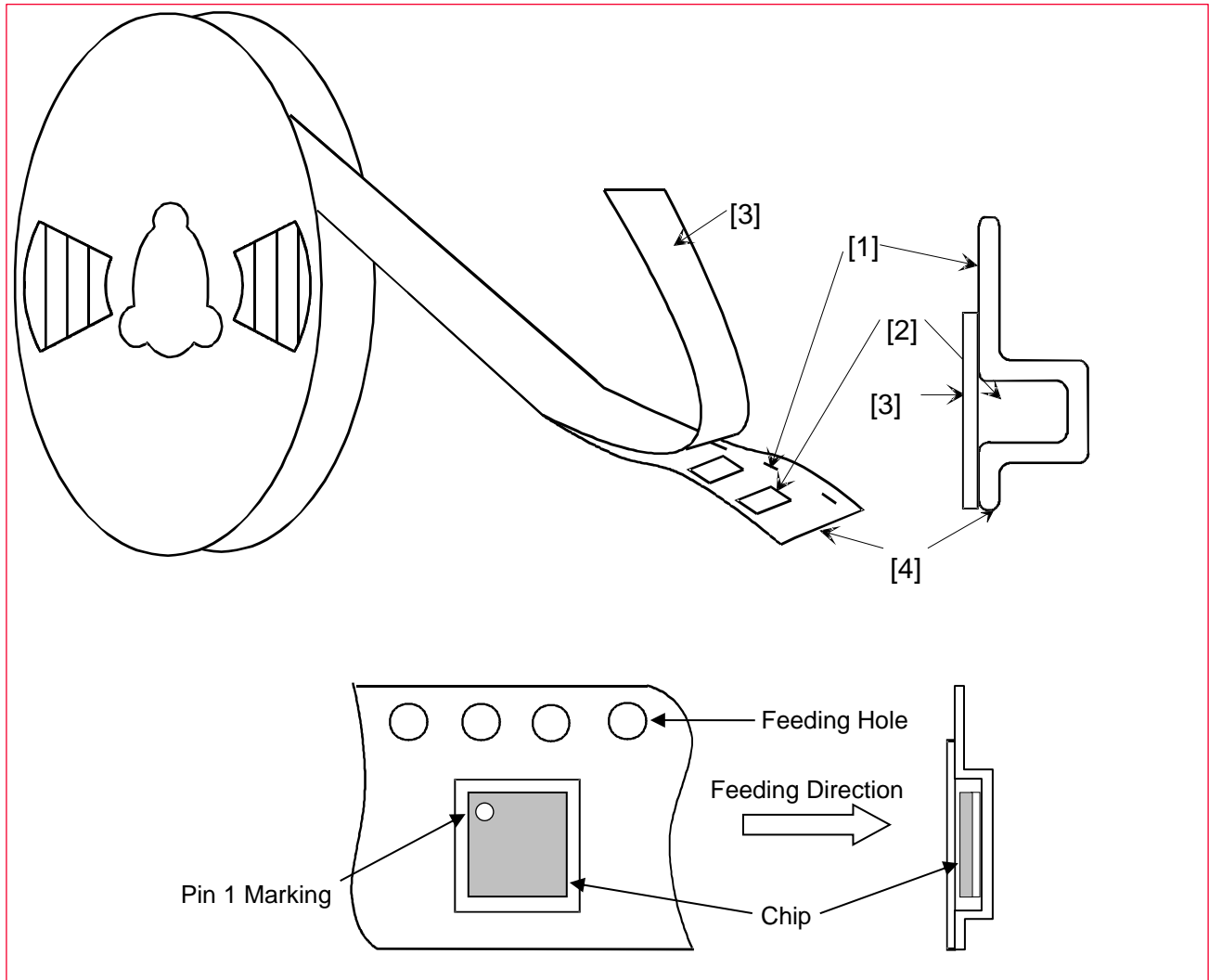

Table 66: Taping Specifications

Mark	Description
1	Feeding Hole. As specified in Dimensions of Tape (Plastic Tape) ☒.
2	Hole for chip. As specified in Dimensions of Tape (Plastic Tape) ☒.
3	Cover tape. 62 μm in thickness.
4	Base tape. As specified in Dimensions of Tape (Plastic Tape) ☒.

14.4 Leader and Tail Tape

The leader and tail tape are shown in **Figure 20**.

Figure 20: Leader and Tail Tape

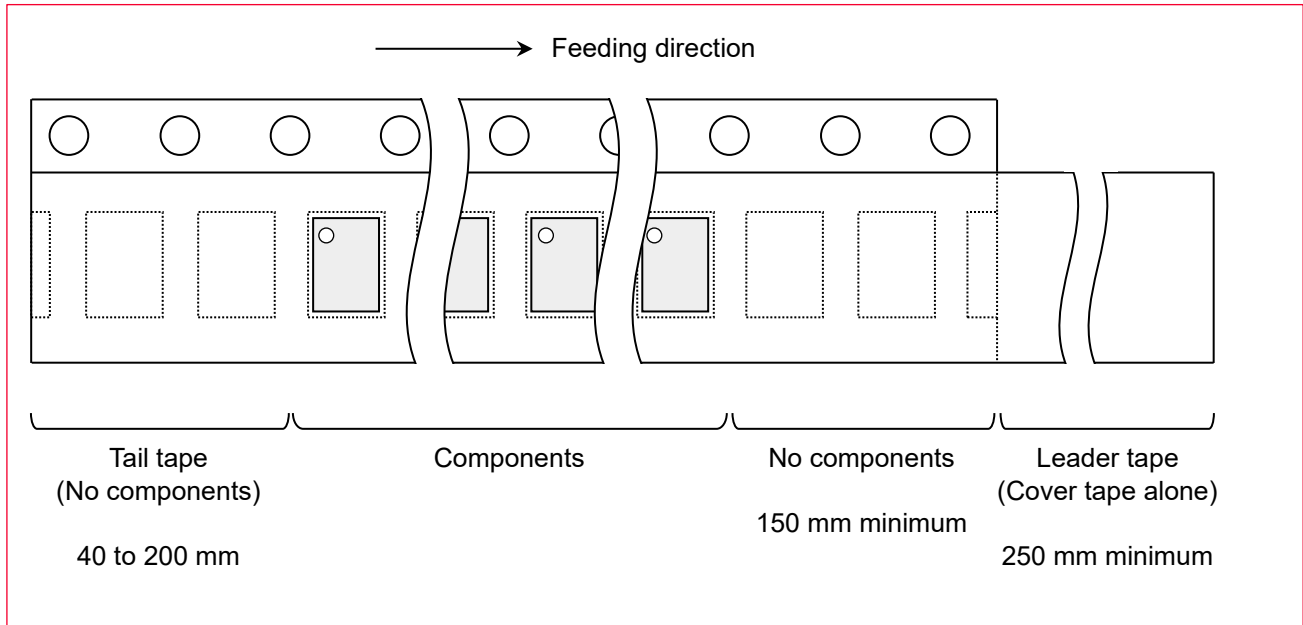

- The tape for chips is wound clockwise, the feeding holes to the right side as the tape is pulled toward the user.
- The cover tape and base tape are not adhered at no components area for 250 mm minimum.
- Tear off strength against pulling of cover tape: 5 N minimum
- Packaging unit: 500 pcs./ reel
- Material
 - Base tape: Plastic
 - Real: Plastic
 - Cover tape, cavity tape and reel are made the anti-static processing.
- Peeling off force: 1.1 N maximum in the direction of peeling as shown in **Figure 21**.

Figure 21: Peeling Force

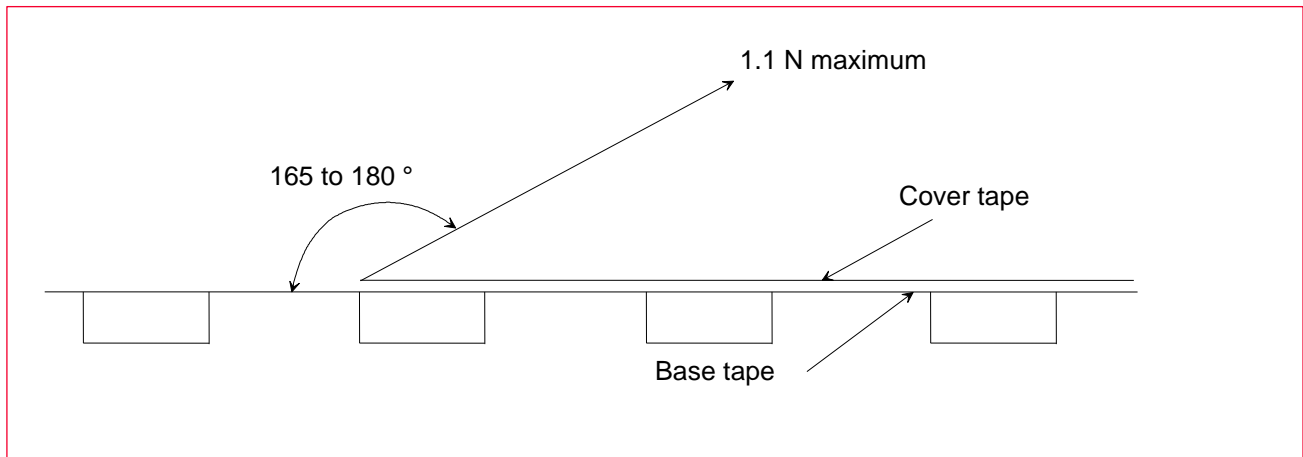

14.5 Packaging (Humidity Proof Packing)

The packaging is shown in **Figure 22**.

Figure 22: Humidity Proof Packing

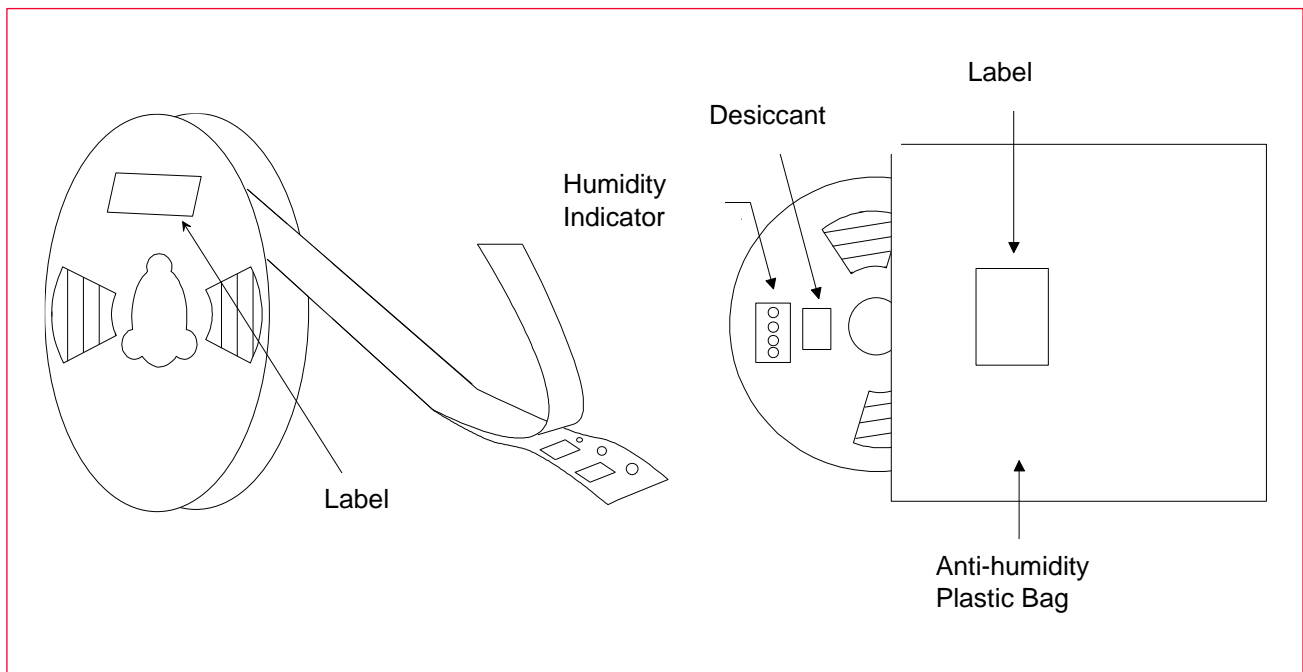

Tape and reel must be sealed with the anti-humidity plastic bag. The bag contains the desiccant and the humidity indicator.

15 Notice

15.1 Storage Conditions

Please use this product within 6 months after receipt.

- The product shall be stored without opening the packing under the ambient temperature from 5 to 35 °C and humidity from 20 ~ 70 %RH.



Packing materials, in particular, may be deformed at the temperature over 40 °C

- The solderability of the product left idle for more than 6 months after receipt needs to be confirmed before it is used.
- The product shall be stored in noncorrosive gas (Cl₂, NH₃, SO₂, NO_x, etc.).
- Any excess mechanical shock including, but not limited to, sticking the packing materials by sharp object, and dropping the product, shall not be applied as that will damage the packing materials.

This product is applicable to MSL3 (Based on IPC/JEDEC J-STD-020)

- After the packing is opened, the product shall be stored at <30 °C / <60 %RH and the product shall be used within 168 hours after opening.
- When the color of the indicator in the packing is changed, the product shall be baked before soldering.
- Baking condition: 125 +5/-0 °C, 24 hours, 1 time
- The products shall be baked on the heat-resistant tray because the material (Base Tape, Reel Tape and Cover Tape) is not heat-resistant.

15.2 Handling Conditions

Be careful while handling or transporting products because excessive stress or mechanical shock may break the products.

Handle with care if you suspect that products may have cracks or damages on their terminals. If there is any such damage, the characteristics of products may change. *Do not touch* products with bare hands as that may cause poor solderability and destroy solderability by static electrical charge.

15.3 Standard PCB Design (Land Pattern and Dimensions)

All the ground terminals should be connected to the ground patterns. Furthermore, the ground pattern should be provided between IN and OUT terminals. Please refer to the specifications for the standard land dimensions.

The recommended land pattern and dimensions is as per Murata's standard. The characteristics of products may vary depending on the pattern drawing method, grounding method, land dimensions, land forming method of the NC terminals and the PCB material and thickness. Therefore, be sure to verify the characteristics in the actual set.



When using non-standard lands, contact Murata in advance.

15.4 Notice for Chip Placer

When placing products on the PCB, products may be stressed and broken by uneven forces from a worn-out chucking locating claw or a suction nozzle. To prevent products from damages, be sure to follow the specifications for the maintenance of the chip placer being used. For the positioning of products on the PCB, be aware that mechanical chucking may damage products.

15.5 Soldering Conditions

The recommendation conditions of soldering are as in **Figure 23**.

Soldering must be carried out by the above-mentioned conditions to prevent products damage. Set up the highest temperature of reflow within 260 °C. Contact Murata before use concerning other soldering conditions.

Figure 23: Reflow Soldering Standard Conditions (Example)

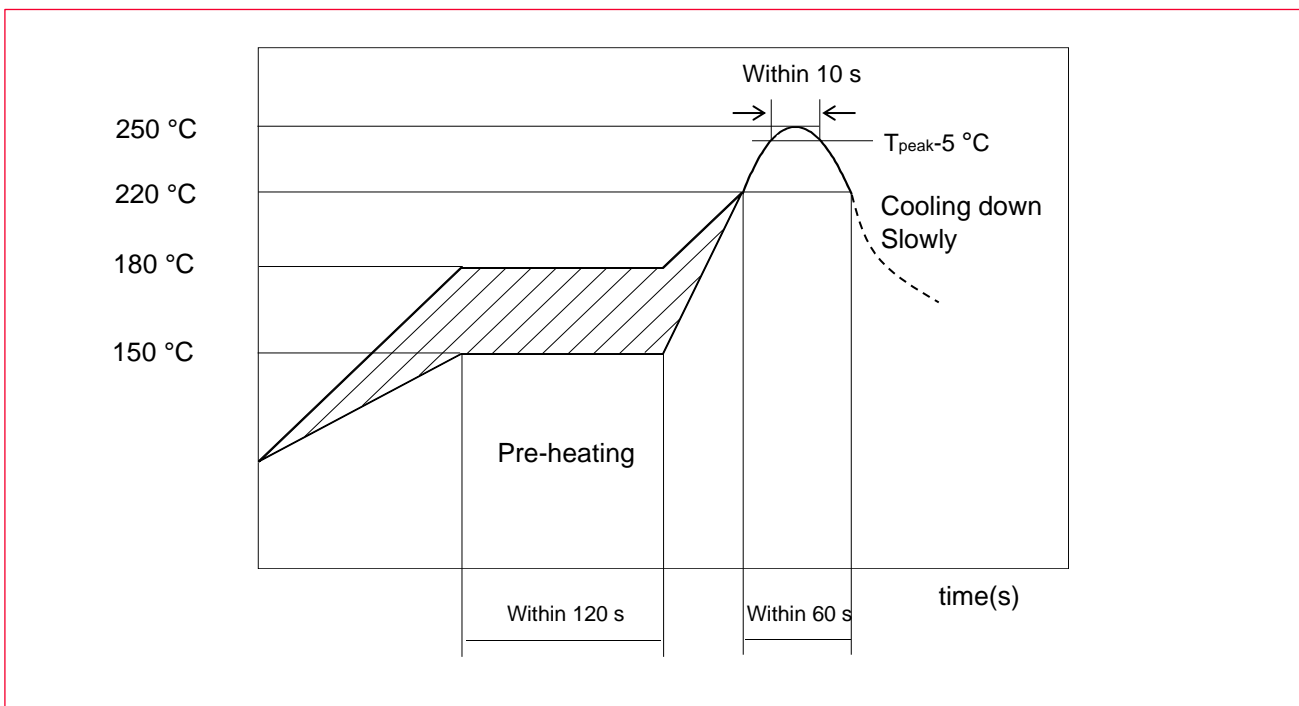

- Please use the reflow within 2 times.
- Use rosin type flux or weakly active flux with a chlorine content of 0.2 wt. % or less.

15.6 Cleaning

Since this product is moisture sensitive, cleaning is not recommended. If any cleaning process is done the customer is responsible for any issues or failures caused by the cleaning process.

15.7 Operational Environment Conditions

Murata products are designed to work for electronic products under normal environmental conditions (ambient temperature, humidity, and pressure). Therefore, there is no problem in using the products under the above-mentioned conditions. However, using the products under the following circumstances may damage products and cause electricity leakage and abnormal temperature may occur:

- In atmosphere containing corrosive gas (Cl₂, NH₃, SO_x, NO_x etc.).
- In atmosphere containing combustible and volatile gases.
- Dusty place.
- Direct sunlight place.
- Water splashing place.
- Humid place where water condenses.
- Freezing place.



If there is any chance of using the products under the conditions listed above, consult with Murata before actual use.



Do not apply static electricity or excessive voltage while assembling and measuring the products, as it might be a cause of degradation or destruction to apply static electricity to products.

This product is not intended for use in applications where strong drop impact is applied. If you want to use it, please use it after fully evaluating it by yourself.

16 Precondition to Use Our Products



PLEASE READ THIS NOTICE BEFORE USING OUR PRODUCTS.

Please make sure that your product has been evaluated and confirmed from the aspect of the fitness for the specifications of our product when our product is mounted to your product.

All the items and parameters in this product specification/datasheet/catalog have been prescribed on the premise that our product is used for the purpose, under the condition and in the environment specified in this specification. You are requested not to use our product deviating from the condition and the environment specified in this specification.

Please note that the only warranty that we provide regarding the products is its conformance to the specifications provided herein. Accordingly, we shall not be responsible for any defects in products or equipment incorporating such products, which are caused under the conditions other than those specified in this specification.

WE HEREBY DISCLAIM ALL OTHER WARRANTIES REGARDING THE PRODUCTS, EXPRESS OR IMPLIED, INCLUDING WITHOUT LIMITATION ANY WARRANTY OF FITNESS FOR A PARTICULAR PURPOSE, THAT THEY ARE DEFECT-FREE, OR AGAINST INFRINGEMENT OF INTELLECTUAL PROPERTY RIGHTS.

You agree that you will use any and all software or program code (including but not limited to firmware, and radio configuration files) we may provide or to be embedded into our product ("Software") provided that you use the Software bundled with our product. YOU AGREE THAT THE SOFTWARE SHALL BE PROVIDED TO YOU "AS IS" BASIS, MURATA MAKES NO REPRESENTATIONS OR WARRANTIES THAT THE SOFTWARE IS ERROR-FREE OR WILL OPERATE WITHOUT INTERRUPTION. AND MORE, MURATA MAKES NO REPRESENTATIONS OR WARRANTIES OF ANY KIND WHETHER EXPRESS OR IMPLIED WITH RESPECT TO THE SOFTWARE. MURATA EXPRESSLY DISCLAIM ANY AND ALL WARRANTIES OR CONDITIONS OF MERCHANTABILITY, FITNESS FOR A PARTICULAR PURPOSE NOR THE WARRANTY OF TITLE OR NON-INFRINGEMENT OF INTELLECTUAL PROPERTY RIGHTS.

You shall indemnify and hold harmless us, our affiliates, and our licensor from and against any and all claims, costs, expenses and liabilities (including attorney's fees), which arise in connection with the using the Software.

The product shall not be used in any application listed below which requires especially high reliability for the prevention of such defect as may directly cause damage to the third party's life, body or property. You acknowledge and agree that, if you use our products in such applications, we will not be responsible for any failure to meet such requirements. Furthermore, YOU AGREE TO INDEMNIFY AND DEFEND US AND OUR AFFILIATES AGAINST ALL CLAIMS, DAMAGES, COSTS, AND EXPENSES THAT MAY BE INCURRED, INCLUDING WITHOUT LIMITATION, ATTORNEY FEES AND COSTS, DUE TO THE USE OF OUR PRODUCTS AND THE SOFTWARE IN SUCH APPLICATIONS.

- Aircraft equipment.
- Aerospace equipment.
- Undersea equipment.
- Power plant control equipment.
- Medical equipment.
- Traffic signal equipment.

- Burning / explosion control equipment.
- Disaster prevention / crime prevention equipment.
- Transportation equipment (vehicles, trains, ships, elevator, etc.).
- Application of similar complexity and/ or reliability requirements to the applications listed in the above.
- We expressly prohibit you from analyzing, breaking, reverse-engineering, remodeling altering, and reproducing our product. Our product cannot be used for the product which is prohibited from being manufactured, used, and sold by the regulations and laws in the world.

Even in the unlikely event that an abnormality or malfunction occurs in this product under operating conditions that conform to the specifications, be sure to add an appropriate fail-safe function to the system to prevent secondary accidents.

We do not warrant or represent that any license, either express or implied, is granted under any our patent right, copyright, mask work right, or our other intellectual property right relating to any combination, machine, or process in which our products or services are used. Information provided by us regarding third-party products or services does not constitute a license from us to use such products or services or a warranty or endorsement thereof. Use of such information may require a license from a third party under the patents or other intellectual property of the third party, or a license from us under our patents or other intellectual property.

Please do not use our products, our technical information and other data provided by us for the purpose of developing of mass-destruction weapons and the purpose of military use.

Moreover, you must comply with "foreign exchange and foreign trade law", the "U.S. export administration regulations", etc.

Please note that we may discontinue the manufacture of our products, due to reasons such as end of supply of materials and/or components from our suppliers.

By signing on specification sheet or approval sheet, you acknowledge that you are the legal representative for your company and that you understand and accept the validity of the contents herein. When you are not able to return the signed version of specification sheet or approval sheet within 30 days from receiving date of specification sheet or approval sheet, it shall be deemed to be your consent on the content of specification sheet or approval sheet. Customer acknowledges that engineering samples may deviate from specifications and may contain defects due to their development status. We reject any liability or product warranty for engineering samples. In particular we disclaim liability for damages caused by

- The use of the engineering sample other than for evaluation purposes, particularly the installation or integration in the product to be sold by you,
- Deviation or lapse in function of engineering sample,
- Improper use of engineering samples.
- We disclaim any liability for consequential and incidental damages.

This Precondition to Use Our Products stipulated in this datasheet can only be modified, amended or altered by documents that explicitly reflect the mutual consent of both parties (including instances where one party explicitly indicates its acceptance of terms provided by the other party through click-through agreements).

If you can't agree with the above contents, please contact sales.

Revision History

Revision Code	Date	Changed Item	Comments
1	2022.02.02	First issue	
2 (A)	2022.04.01	5.1 Radio Certification 5.2 Bluetooth Qualification 6. Dimensions, Marking and Terminal Configurations 9.1 Operating conditions 9.2 Digital I/O Requirements 9.3 Package thermal conditions 11. Host Interface Specification 12.14 DC/RF Characteristics for Bluetooth 12.15 DC/RF Characteristics for Bluetooth	<ul style="list-style-type: none"> Added certification number Added qualification number Added module structure, Defined T1. Added Junction temperature Added this section Added this section Added this section Added test method Added test method
3 (B)	2022.05.09	6. Dimensions, Marking and Terminal Configurations 9.1 Operating conditions 12. DC/RF Characteristics	<ul style="list-style-type: none"> Modified b3 measurement Defined maximum values of peak current. Defined current consumption and maximum input level
4 (C)	2022.05.31	7.2 Pin Descriptions 7.4 Pin States 14. Reference circuit	<ul style="list-style-type: none"> Updated supply voltage level of IO pins (Power domain) Updated supply voltage level of IO pins (Power domain) Connect Pin 82 to GND. Added comment on GPIO22/23.
5 (D)	2022.08.26	7.2 Pin Descriptions 9.1 Operating Condition 9.3 Package Thermal Conditions 14. Reference Circuit	<ul style="list-style-type: none"> Corrected descriptions of Pin 56, Pin 65, Pin 70, Pin 72 and Pin76 Added Notes. Corrected value. Corrected connection of Pin 20 and 21.
6 (E)	2022.10.03	2. Key Features 3. Part Number 6. Dimensions, Marking and Terminal Configurations 7.4 Pin States 10. Power-Up / Power-Down Sequence 14. Reference Circuit	<ul style="list-style-type: none"> Added more information Added Embedded Artists' M.2 module information. Renamed section. Corrected e9 of dimensions Added comments on termination of open pins. Renamed section Moved section to HW app note. <p>Updated to new format</p>
7 (F)	2023.06.29	2 Key Feature 7.2 Pin Descriptions 7.3 Configuration Pins 7.4 Pin State 7.5 SDIO Pin Descriptions 9.1 Operating conditions 9.3 Package thermal conditions	<ul style="list-style-type: none"> Corrected typo (MCS9 > 11) Added B10 life and Fit Updated CONFIG_HOST[2] Updated GPIO[14] Changed IO Voltage of PCIE_CLKREQn and PCIE_WAKEn Removed DSRn and DRTn Removed SDIO 1-bit mode Added comments Updated GPIO[14] [15] [17] Removed SDIO 1-bit mode Updated Ta and Added Tc

		10.1 Power-On Sequence 10.2 Power-Off Sequence 11.1 SDIO Specifications 14. Radio Regulatory Certification by Country for 1XL/2XS	<ul style="list-style-type: none"> • Removed • Updated sequence • Added comment • Removed SDIO 1-bit mode • Added Radio Regulatory Certification
8 (G)	2024.07.29	4 Block Diagram 5.3 Bluetooth Qualification 16.7 Operational Environment Conditions (Base IC datasheet revision : 11)	<ul style="list-style-type: none"> • Updated Figure 1 • Added DID/DN • Add Warning Note
9	2025.02.14	Revision History 12. DC/RF Characteristics (14. Radio Regulatory Cert...) 16. Preconditions to Use...	<ul style="list-style-type: none"> • Changed revision rule • Corrected typo of spectrum mask • Removed the section • Updated



Copyright © Murata Manufacturing Co., Ltd. All rights reserved. The information and content in this document are provided “as-is” with no warranties of any kind and are for informational purpose only. Data and information have been carefully checked and are believed to be accurate; however, no liability or responsibility for any errors, omissions, or inaccuracies is assumed.

The Bluetooth® word mark and logos are registered trademarks owned by Bluetooth SIG, Inc. Other brand and product names are trademarks or registered trademarks of their respective owners.

Specifications are subject to change without notice.