



FEATURES

- Compact high-density design with operation:
 - Up to 800W natural convection
 - 1000W with forced convection airflow at +50 °C, no derating with input line voltage
- Optional cover kits available (with or without fan)
- Voltage adjustment (-5% + 10%) of main V1 output
- +5Aux/Standby (V2) and 12V (V3) fan outputs
- 5" x 8" (127mm x 203.2mm) industry standard footprint, "U" channel form factor with industry "standard" mounting footprints:
 - 39.97mm maximum overall "U" channel height
 - 45.60mm nominal overall height with cover
 - 67.93mm nominal overall height with integral fan cover
- High-efficiency of 95% typical at 50% load
- True zero load operation of the main (V1) output; no minimum load requirements
- Remote sense for the main output
- Universal AC input; active PFC; EN61000-3-2 Class A
- MTBF 1135Khrs, Telcordia SR332 Issue 3, M1 Case 3
- RoHS compliant
- Active inrush protection and current share
- IEC 60601-1 Ed.3 medical (2x MOPP Pri-Sec)
- IEC 62368-1
- Applied Part BF rating (isolation and patient leakage current)
- 1 X MOPP Pri-chassis ground
- Two-year warranty

SAFETY APPROVALS

- UL 62368-1 2nd Edition
- CSA C22.2 No. 62368-1-14
- IEC 62368-1:2014
- IEC 60601-1:2005/AMD1:2012



PRODUCT OVERVIEW

PQU1000 is a series of 1000W power supply converters, powered by wide range AC input, and offered in a compact 5" x 8" industry standard format. 1000W¹ continuous output power can be achieved with forced convection, and up to an impressive 800W³, at +50°C with natural convection airflow. All variants are provided with constant current overload protection allowing operation with motors, solenoids, and high capacitance loads.

Active current sharing supports connection of PQU1000 power modules in either non-redundant parallel, or parallel redundant deployments, whilst maintaining equal current share between modules. The adjustable main output, standby/auxiliary, and fan outputs, plus PMBus™ Power Management Bus enable this series for deployment across multiple market sectors, complemented by safety certification applicable to medical, audio, video, communication, and ITE standards.

ORDERING GUIDE

Part Number ¹	Main Output		Aux Output (v2)		Fan Output (v3) ⁴	
	Voltage (VDC)	Current Adc @ 50°C, 1000W ¹	Vdc	Current (Adc @ 50°C)	Vdc	Current (Adc @ 50°C)
PQU1000-12	12	83.3	5	1.0	12	1.0
PQU1000-24	24	41.7				
PQU1000-48 ²	48	20.8				
PQU1000-54 ²	54	18.5				

¹ Requires external system airflow or PQU1000-FT-COVER with integral fan.

² PoE isolation compliant.

³ Minor derating is required.

⁴ Only available for forced air cooled deployments (not rated for convection cooled (deployments)).

INPUT CHARACTERISTICS

Parameter	Conditions	Min.	Nom.	Max.	Units
Input Voltage AC Operating Range	Single Phase	90 ¹	100/240	264	V _{AC}
Input Frequency		47	50/60	63	Hz
Turn-on input voltage	Input rising	75 ¹		90	V _{AC}
Turn-off input voltage	Input falling	65		80	V _{AC}
Maximum input current (target)	V _{in} = 90V _{AC} ; Full Load (1000W FL)			13	Arms
Inrush Current	230V _{AC} ; Cold start, 25°C;			50	Apk
Power Factor	At 115V _{AC} /230V _{AC} , Full Load	0.95			W/VA
Hold-up Time (Target)	90V _{AC} ; Full Load	10			ms
Target Efficiency @ 230V _{AC}	20% Full Load		92		%
	50% Full Load		95		
	100% Full Load		95		

¹ Operation at 80V_{AC} is possible at 650W and +50°C; however, the specification is not guaranteed at an input voltage of less than 90V_{AC}.

MAIN OUTPUT CHARACTERISTICS (all models)

Parameter	Conditions	Min.	Nom.	Max.	Units
Line, Load Regulation	Main (V1) Output ¹			±5	%
Minimum Load Capability	Stable Operation	0			A
Output Ripple	Zero to Full Load ²			1%	mV _{PP}
Transient Response ³	50% load step, 1A/μsec slew rate and min 10% load (for example, 10% to 60%; 100% to 50%).			± 5	%
Settling Time to 1% of Nominal				2	msec
Turn On Delay	After application of input power.			3	sec
Output Voltage Rise			200		msec
Remote Sense ⁴	Compensates for up to 500mV of total lead drop (output and return connections) with remote sense connected. Protected against short circuit and reverse connection.			1	%

¹ Zero load output voltage might exceed the regulation window; however, it does not cause the OVP to engage or PWOK to change to low state.

² Ripple and noise are measured with 0.1μF ceramic capacitor and 10μF tantalum capacitor. A short coaxial cable with 50-ohm termination is used. Min 120μF cap required at the output to keep ripple within 1% for 54V output. Min 10% load current required to maintain ripple within 1% for the 12V output model. 1A min load for all other models.

³ Minimum of one second time between consecutive transients; requires 10% minimum load.

⁴ If remote sense is left unterminated (floating) then the output voltage set point increases by 500mV_{DC}.

AUXILIARY OUTPUT CHARACTERISTICS

Auxiliary Output	Auxiliary Output Voltage	Load Current	Load Capacitance	Line, Load, Cross Regulation	Ripple Voltage
Aux (V2)	5V	0 to 0.5A	0 to 220µF	4.75 to 5.25Vdc	100mVPP

FAN OUTPUT CHARACTERISTICS (all models)

Auxiliary Output	Auxiliary Output Voltage	Load Current	Load Capacitance	Line, Load, Cross Regulation	Ripple Voltage
Aux (V3)	12V	0 to 0.6A	0 to 220µF	10.8 to 13.2Vdc	120mVPP

MAIN OUTPUT CHARACTERISTICS (all models unless otherwise noted)

Parameter	Conditions	Typ.	Max.	Units
Transient Response ¹	50% load step, 1A/µsec slew rate and min 10% load (for example, 10% to 60%; 100% to 50%).		± 5	%
Settling Time to 1% of Nominal			2	msec
Turn On Delay	After application of input power.		3	sec
Output Voltage Rise		200		msec
Remote Sense ²	Compensates for up to 500mV of total lead drop (output and return connections) with remote sense connected. Protected against short circuit and reverse connection.		1	%

¹ Minimum of one second time between consecutive transients; requires 10% minimum load.

² If the remote sense is left unterminated (floating) then the output voltage set point increases by 500mVdc.

ENVIRONMENTAL CHARACTERISTICS

Parameter	Conditions	Min.	Typ.	Max.	Units
Storage Temperature Range		-40		85	°C
Operating Temperature Range ²	See power derating curves	-30		70	
Operating Humidity	Non-condensing	10		95	%
Operating Altitude		0		5000	m
MTBF	Telcordia SR-332 Issue 3; M1C3 @ 25°C Telcordia SR-332 Issue 3; M1C3 @ 40°C		2140K 1135K		Hours
Shock	30G, non-operating; Validation testing per IEC 60068-2-27, test Ea. 30G, 11msec half-sine, 3 shocks per face, 6 faces				Complies
Operational Vibration	Sine Sweep; 5-150Hz, 2G Random Vibration, 5-500Hz, 1.11G				Complies
Safety – Medical Standards ¹ 2 x MOPP (Primary-Secondary) Applied Part Type BF	IEC 60601-1:2005/AMD1:2012 [TÜV SÜD] CAN/CSA-C22.2 No. 60601-1:2014 [TÜV SÜD] ANSI/AAMI ES60601-1:2005/A1:2012-08 [TÜV SÜD] EN 60601-1:2006/A1:2013 [TÜV SÜD]				
Safety – ITE, Audio/Video/Communications & Consumer Standards ¹	IEC 62368-1:2014 [CSA] CAN/CSA-C22.2 No. 62368-1:14[CSA] UL 62368-1 2nd Ed. [CSA] GB 17625.1-2022; GB 4943.1-2022; GB/T 9254-2021 (Class A) [CCC] EN IEC 62368-1:2020/A11:2020 [TÜV SÜD] CE [Self-Declaration] UKCA [Self-Declaration]				
Fuses (Input)	Dual Fuses; Line and Neutral; 16A Fast Acting; 250V				
Outside Dimensions ("U" Channel only).	5.0" x 8.0" x 1.69" (127.0mm x 203.2mm x 40.0mm) nominal				
Weight	1.18/2.60				kg/lbs.

¹ Meets 5000 M max. altitude for medical certification requirements.

² Starts up at -40°C; however, full specification guaranteed at -30°C.

ISOLATION CHARACTERISTICS					
Parameter	Conditions	Min.	Typ.	Max.	Units
Isolation	Primary to chassis	1500			Vac ²
	Primary to secondary (2xMOOP)	4800			
	Secondary to Chassis ¹	1500			
	Main output to other outputs ¹	1500			
Touch Currents (IEC62368-1)	264Vac, 60Hz, 25°C			1.5	mApk
Patient Leakage Current (under normal conditions)	Meets relevant max Type B and BF patient leakage current limits			100	µA

¹ Meets PoE isolation limits.

² Isolation is verified during safety compliance testing by the use of an equivalent DC voltage as defined by IEC60601-1 3rd Edition; Section 8.8.3 using values as per Table 6, based upon the relevant peak working voltage.

PROTECTION CHARACTERISTICS					
Parameter	Conditions	Min.	Typ.	Max.	Units
Over Voltage Protection	V1 (main output) latching	110		140	%Vdc ²
	V1 (48V & 54V models) latching			60	Vdc
	V2 (aux output) latching			7.5	
Over Current Protection	V1, See Constant Current curves below				
	V2, cycling, auto-	110		150	%
	V3; non-resettable fuse ¹			1.5	Adc
Over Temperature Protection	Primary Heatsink Temperature			130	°C
	Secondary Temperature			130	
Remote Sense Short Circuit Protection			Complies		--
Remote Sense Reverse Connection Protection			Complies		--

¹ OCP of the 12V Fan (V3) output is provided by a non-user replaceable SMD fuse rated at 1.5A; therefore, if ruptured the 12V Fan output is not available and the fuse must be replaced.

² Refers to percentage of nominal voltage.

CONSTANT CURRENT CHARACTERISTICS

The idealized Constant Current characteristics are shown in the following curves. This feature enables the PQU1000 to successfully start into application loads exhibiting large inrush current. For example, large capacitive loads, incandescent lamps, motors and solenoids.

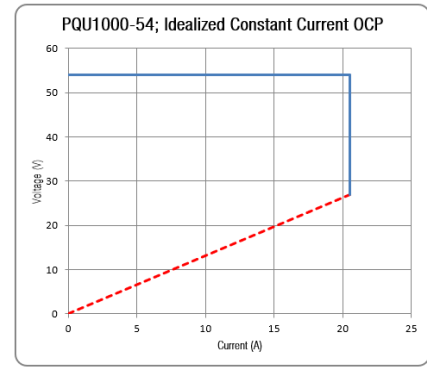
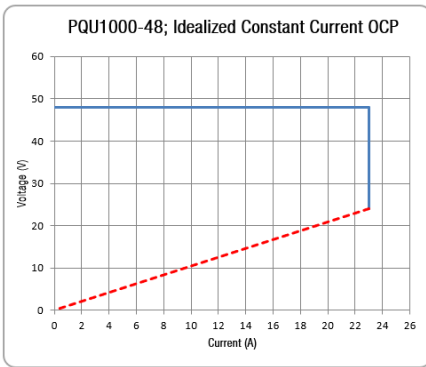
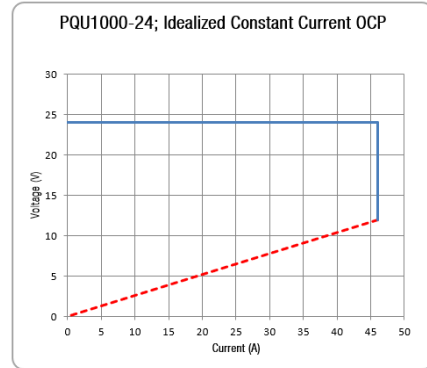
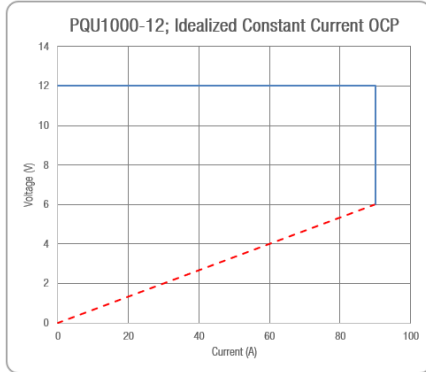

1. Curves generated for the PQU1000 variants by subjecting output to an incremental (constant resistance load, equivalent to 1A increments (above full load).
2. The resultant curve shows the current limited to a constant "brick wall" shown by the blue portion of curve.
3. If the load current is further incremented the output will enter "hiccup" (recycling on/off) shown by the red dashed curve, commencing when the output voltage falls to ~50% of the nominal set point.
4. If the overload current is maintained above maximum load for an extended period, the "hiccup" operation continues indefinitely while the overload persists. If the overload is maintained below where the "hiccup" operation is initiated, the power module can enter thermal protection (dependent on the prevailing operating conditions).

CURRENT SHARING

Model Number	Description
All PQU1000 Variants	Main output adapts active current sharing. The current sharing signal is connected between sharing units to form an ISHARE signal bus.
	The sharing signal is bi-directional analogue bus and acts as an input and/or an output as the voltage on the signal line controls the current share between sharing units.
	A power supply will respond to a change in this voltage; however, a power supply can also change the voltage depending on the load drawn from it.
	On a single unit the voltage on the pin (and the common ISHARE bus would read approximately 8Vdc at 100% load (module capability).
	For two identical voltage variants sharing the same 100% load this would read approximately 4Vdc for perfect current sharing (for example, 50% module load capability per unit).
	Startup of parallel power supplies is not internally synchronized; no more than 1000W combined power is allowed at start-up. To account for $\pm 10\%$ full load current sharing accuracy, the output power must be derated by 15% when units are operated in parallel. Current sharing can be achieved with or without remote sense connected to the common load. External ORING protection is recommended (see Application notes, ACAN-127 for additional details).
The +5V_STANDBY (Aux) V2 outputs cannot be tied together for increased power or redundancy; however, +5V_STANDBY_RTN can be tied together to create a common return for the signals between units that share the Main V1 output.	
It is not recommended that the 12V Fan (V3) outputs are connected in parallel since these outputs are only semi regulated, and only intended to supply an external fan (or that of the PQU1000-FT-COVER integral fan).	

EMISSIONS AND IMMUNITY

Characteristic	Standard	Compliance
Input Current Harmonics	IEC/EN 61000-3-2	Class A
Voltage Fluctuation and Flicker	IEC/EN 61000-3-3	Complies
Conducted Emissions	CISPR 32/EN 55032	Class B
	FCC Part 15	Class B
Radiated Emissions	CISPR 32/EN 55032	Class A
	FCC 15.109 - 3 meter	Class A
ESD Immunity	IEC/EN 61000-4-2	Level 4, Criterion B
Radiated Field Immunity	IEC/EN 61000-4-3	Level 3, Criterion A
Electrical Fast Transient Immunity	IEC/EN 61000-4-4	Level 3, Criterion A
Surge Immunity	IEC/EN 61000-4-5	Level 3, Criterion A (Com. Mode: 2kV 12 ohm, Diff. Mode: 1kV, 2 ohm)
Radiated Field Conducted Immunity	IEC/EN 61000-4-6	Level 3, 10V/m, Criterion A
Magnetic Field Immunity	IEC/EN 61000-4-8	Level 3, Criterion A
Voltage dips, interruptions	IEC/EN 61000-4-11	Level 3, Criterion B

EMI CONSIDERATIONS

To comply with safety standards, the input connector must be properly grounded to protective earth (see mechanical dimension notes).

Pre-compliance testing has shown the stand-alone power supply to comply with EN55032 class A radiated emissions; testing was based on adding a toroid (4 turns of both main output wires wound as common mode choke on FAIR-RITE#5961002701). Radiated emission results vary with system enclosure and cable routing paths.

A minimum 10% load current is required on the main output.

STATUS AND CONTROL SIGNALS TABLE

Signal Name	I/O	Description	Interface Details
DC_OK_H J301 Pin 2	Output	The signal is asserted, driven high, by the power module to indicate that all outputs are valid. If the V1 (Main) and V2 (+5V_STANDBY) outputs fail, then this output will be driven low.	Pulled up internally to 10K to VDD ¹ A logic high >2.0Vdc A logic low <0.8Vdc Driven low by internal CMOS buffer (open drain output).
PS_ON_H (V1 Main Output Enable/Disable) J301 Pin 4	Input	The PS_ON_H signal is intended to be unterminated (open circuit) or pulled up to V2 +5V_AUX the V1 Main output to "turn on" (enable) the Main V1 Output. To turn "off" (disable) the Main V1 output the PS_ON shall be pulled low (sink current >2mA) to +5V_AUX_RTN. This pin must be pulled low (sink current >2mA) to +5V_AUX_RTN to turn off the main output. The +5V_AUX output is independent of the PS_ON_H signal and comes up automatically when the input AC source is applied within specified operating ranges. The +5V_AUX output is independent of the PS_ON_H signal and comes up automatically when the input AC source is applied within specified operating ranges.	The PS_ON_H signal is intended to be unterminated (open circuit) or pulled up to V2 +5V_AUX. Sink current >2mA) to +5V_AUX_RTN to turn off the main output.
AC_OK_H J301 Pin 3	Output	The signal output is driven high when input source is available and within acceptable limits. The output is driven low to indicate loss of input power. There is a minimum of 1ms pre-warning time before the signal is driven low prior to the PWR_OK signal going low. The power supply must ensure that this interface signal provides accurate status when AC power is lost.	Pulled up internally via 10K to 3.3Vdc. A logic high >2.0Vdc A logic low <0.8Vdc Driven low by internal CMOS buffer (open drain output).
+VE SENSE; J702 Pin 2 -VE SENSE_Return; J702 Pin 4	Input	Sense connections are provided to compensate for the voltage drop in cables to the load. The voltage sense will interact with the internal module regulation loop to compensate for voltage drops due to connection resistance between the output connector and the load. Local sensing can be achieved in two ways: <ul style="list-style-type: none"> • If the ISHARE function is not required, then jumper (headers) can be fitted between J702 Pins 1 & 2 and J702 Pins 4 & 5 (see Mechanical Outline section for additional details). • If ISHARE is required (i.e. load sharing between parallel connected modules) then jumper wires/cables can be fitted to the mating connector between J702 Pins 1 & 2 and J702 Pins 4 & 5. If (remote) sensing at the load is required, then cables can be extended from the mating connector to the load: <ul style="list-style-type: none"> • +VE SENSE, J702 Pin 2 connected to +VE of the load • -VE SENSE_Return, J702 Pin 4, connected to -VE_MAIN_Return (J4 Pin4). 	Compensation for up to 0.5Vdc total connection drop (output and return connection).
ISHARE J702 Pin 3	I/O	The current sharing signal is connected between sharing units (forming an ISHARE bus). It is an input and/or an output (bi-directional analogue bus) as the voltage on the line controls the current share between sharing units. A power supply will respond to a change in this voltage, but a power supply can also change the voltage depending on the load drawn from it. On a single unit the voltage on the pin (and the common ISHARE bus would read approximately 8Vdc at 100% load (module capability). For two identical units sharing the same 100% total load the ISHARE bus would read approximately 4Vdc for perfect current sharing (i.e. 50% module load capability per unit).	Analogue voltage: Approximately +8Vdc maximum; 10K to VE_MAIN_Return

STATUS AND CONTROL SIGNALS TABLE

Signal Name	I/O	Description	Interface Details		
ADDR J301 Pin 5	Input	An analog input that is used to set the address of the internal slave devices (EEPROM and microprocessor) used for digital communications.	DC voltage between the limits of 0 and +3.3Vdc.		
		Connection of a suitable resistor to +VSB_Return, in conjunction with an internal resistor divider chain configures the required address.			
		The external resistor shall enable up to eight separate addresses to be configured.			
		HEX Address Combinations by Analogue Method; ADDR External Resistance Values			
		ADDR External Resistance to RTN/Ground (KΩ; ±5% Tolerance)		Power Module Secondary Main Controller (Serial Slave Address)*	Serial EEPROM Device
		0.82		0xB0	0xA0
		2.7		0xB2	0xA2
		5.6		0xB4	0xA4
8.2	0xB6	0xA6			
15	0xB8	0xA8			
27	0xBA	0xAA			
56	0xBC	0xAC			
180	0xBE	0xAE			
SMB_ALERT J301 Pin 6	Output	<p>The signal output is driven low to indicate that the power supply has detected a warning or fault and is intended to alert the system. This output must be driven high when the power is operating correctly (within specified limits).</p> <p>The signal will revert to a high level when the warning/fault stimulus (that caused the alert) is removed. As reported by PMBus™ STATUS_X Registers with exception of STATUS_CML.</p>	<p>Pulled up internally via 10K to VDD*.</p> <p>A logic high >2.0Vdc A logic low <0.8Vdc</p> <p>Driven low by internal CMOS buffer (open drain output).</p>		

*VDD is an internal voltage rail derived from VSB and an internal housekeeping rail ("diode ORED") and is compatible with the voltage tolerances of VSB). For robust PMBus communications, it is recommended SDA and SCA lines be pulled up via external resistors to a voltage of 3.3V or greater.

STATUS LEDS

Dual (Red and Green) LEDES

PSU Status	LED Status
Output on and OK	Green
AC power not present	Off
Standby state; AC present; Main output off, VSB on	1Hz Blink Green
Power supply critical event causing a shutdown; failure, overcurrent, short circuit, overvoltage, fan failure, over temperature	Red
Power supply warning events where the power supply continues to operate; high temperature, high power, high current	1Hz Blink Red

PART NUMBER STRUCTURE

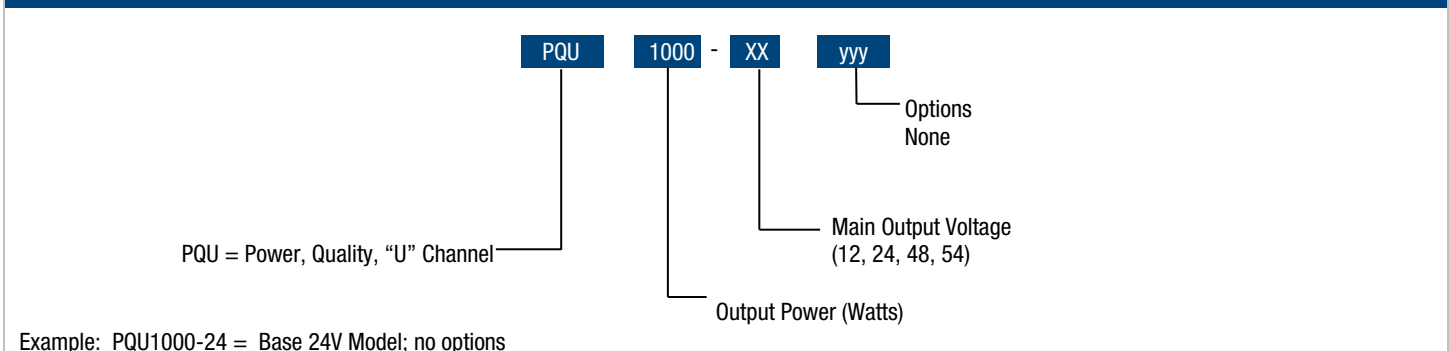

TYPICAL PERFORMANCE DATA EXAMPLES

Efficiency PQU1000-12

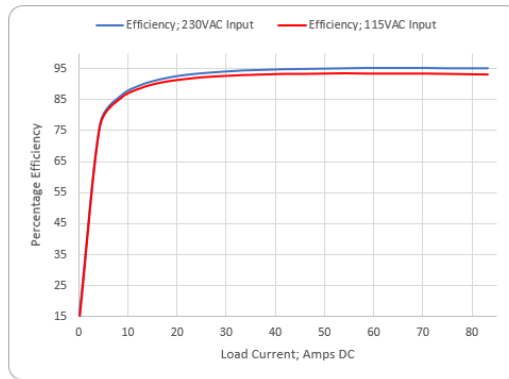

Efficiency PQU1000-24

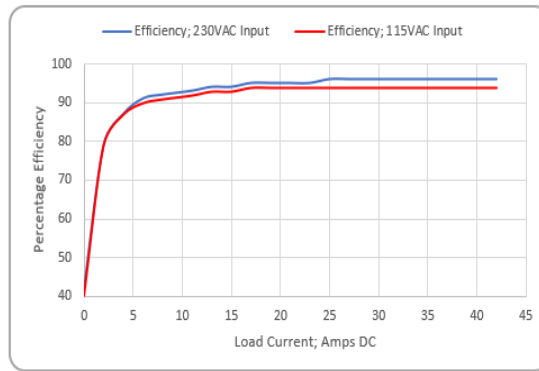

Efficiency PQU1000-48

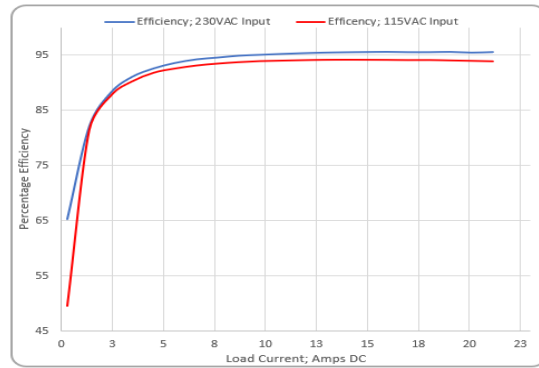

Efficiency PQU1000-54

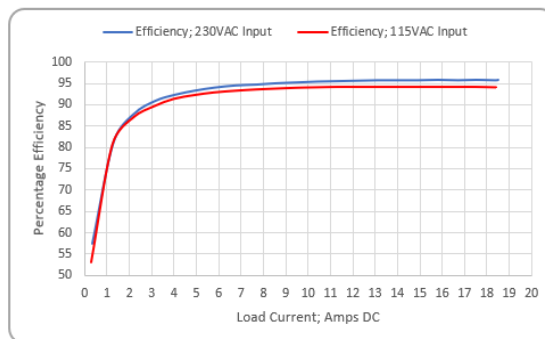

TYPICAL PERFORMANCE DATA EXAMPLES

Ripple & Noise PQU1000-12; Full Load; 264Vac Input

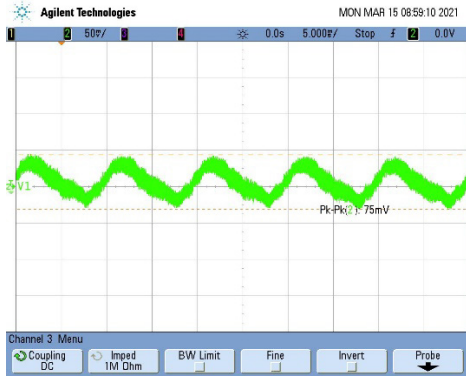

Ripple & Noise; PQU1000-24; Full Load; 264Vac Input

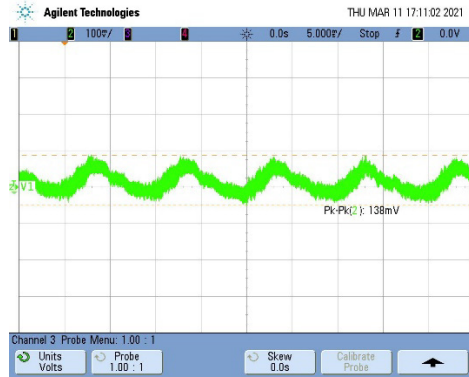

Ripple & Noise PQU1000-48; Full Load; 264Vac Input

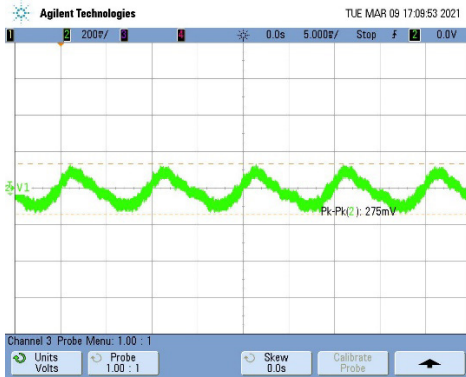

Ripple & Noise; PQU1000-54; Full Load; 264Vac Input



Transient Performance, 24V Model Half to Full Load

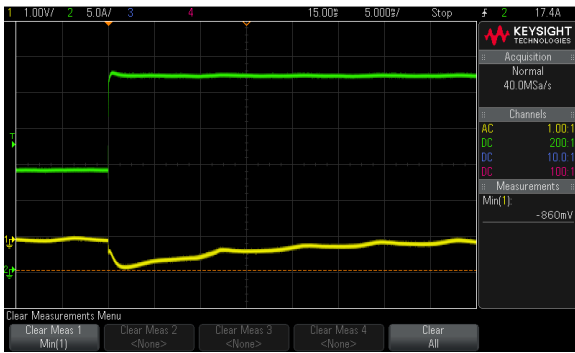

Transient Performance, 24V Model Full to Half Load

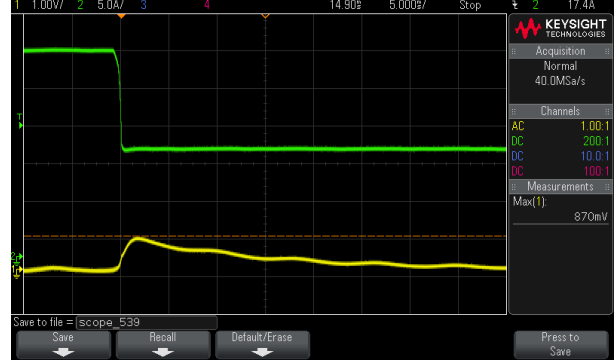

Inrush Current; 264Vac Input, Cold Start, Full Load; 31.4Apk

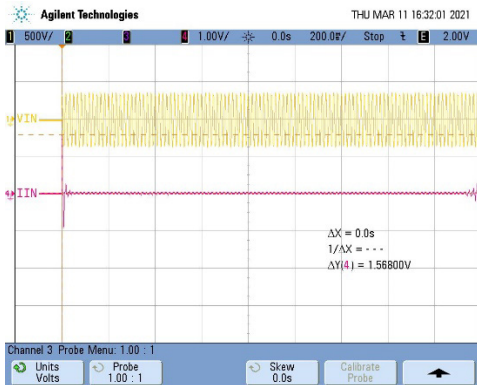

Hold Up Time; 90Vac; 1000W; 16.35ms



TYPICAL EMI PERFORMANCE DATA EXAMPLES

EMI; Conducted CISPR 32/EN55032 Class B; Peak vs. Average Limit; 120Vac 12Vdc @ 82A dc

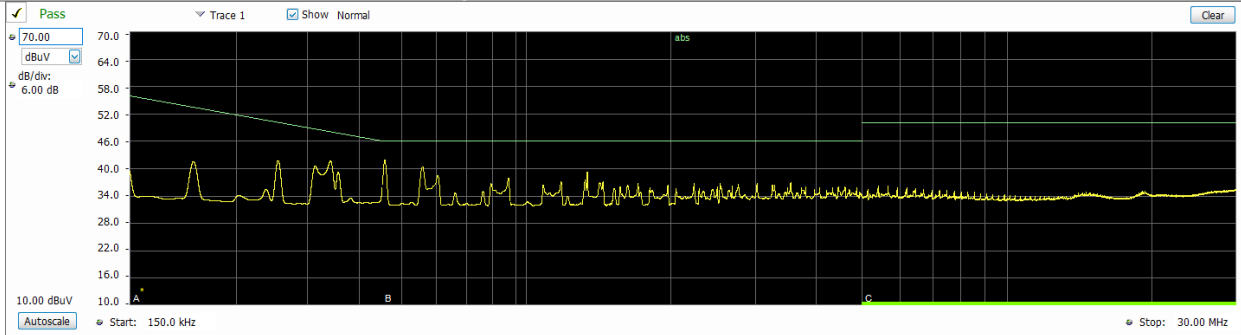

EMI; Conducted CISPR 22; QP Limit; 120Vac 12Vdc @ 82A dc

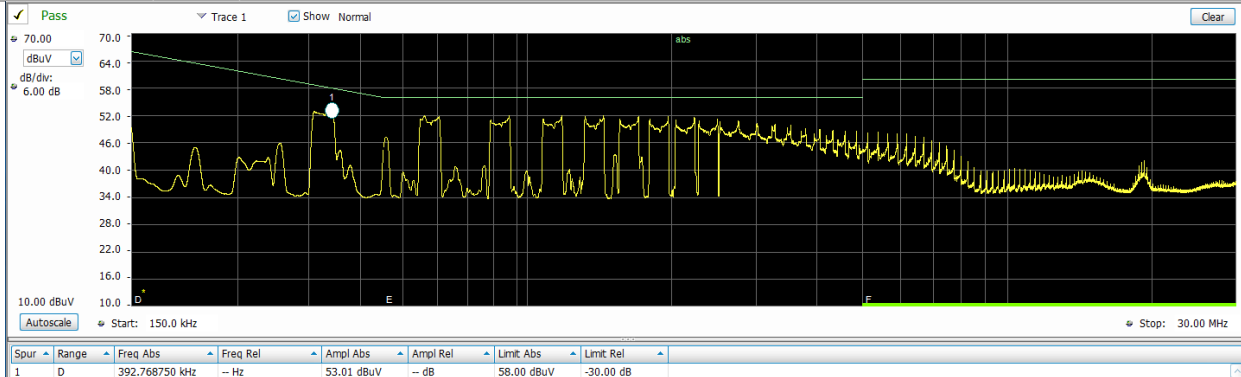

EMI; Conducted CISPR 22; Peak vs. Average Limit; L1; 208Vac 12Vdc @ 82A dc

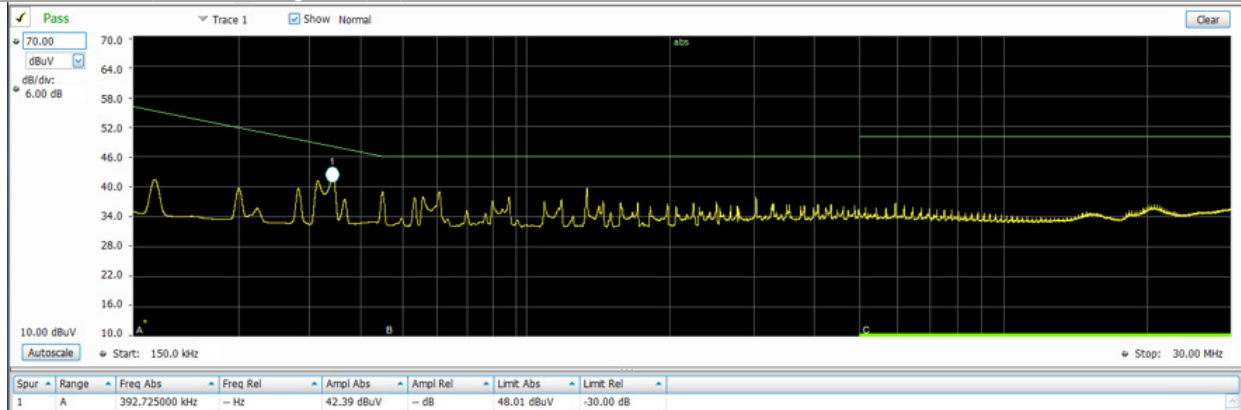

EMI; Conducted CISPR 22; QP Limit; 208Vac 12Vdc @ 82A dc

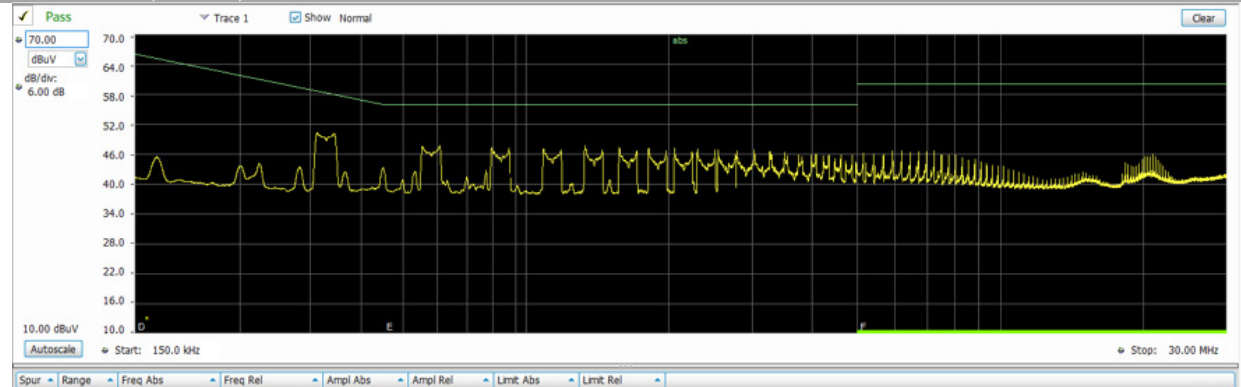

THERMAL CONSIDERATIONS

System thermal management is critical to the performance and reliability of the PQU1000 series power supplies.

The product is designed to provide 800W using natural convection cooling when mounted with un-obstructed convection current airflow flow at up to +50°C local ambient temperature. At elevated temperatures the power supply data is taken while it is surrounded by a large vented enclosure to minimize forced cross flows inherent in the elevated temperature test.

The product is capable of operation when mounted in diverse orientations; operational/derating curves shall be provided to show the effect of such mounting. See ACAN-128 for additional details.

Capacitor Case Temperature and Mounting Orientation

The power supply can operate in any orientation; however, the power supply contains overtemperature protection that will shut off the output as the temperature of critical componenets exceed their safe and reliable thermal limits.

The life expectancy of the power supply is inversely proportional to the case temperature of electrolytic capacitors. The designer of the system in which this power module is deployed should consider this relationship to ensure optimum product life. The following charts are life predications (based on 80% of full load capability) that illustrate this relationship.

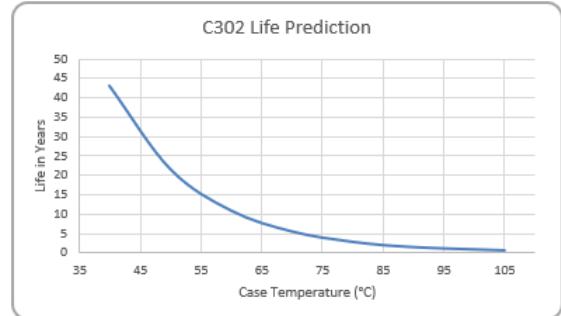
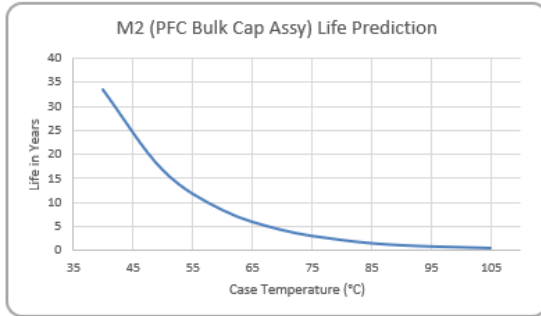

The PQU1000 Series also benefits from the provision of forced convection cooling airflow either generated by an external host system fan or by a fan integral to the PQU1000-FT COVER assembly.

A dedicated 12V Fan (V3) output is provided that can be used to power an external (system) fan, or that of the PQU1000-FT-COVER.

This enables operation to the full capability of 1000W at +50°C local ambient (forced convection cooling air) temperature.

NB: The above curves are based on generic predicted life.

DERATING CURVES

Thermal; Convection "U" Channel

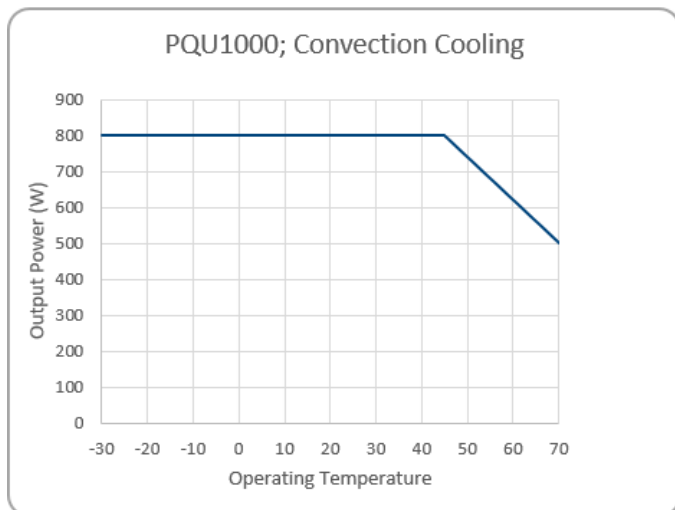

- The PQU1000 reliably provides 750W cooled by natural convection at 90Vac input, at a local ambient temperature of +50C.
- Slight derating is applied with temperature from +45°C operation, linearly derating to 500W at +70°C.

Thermal; Top Mounted Fan Convection Cooled

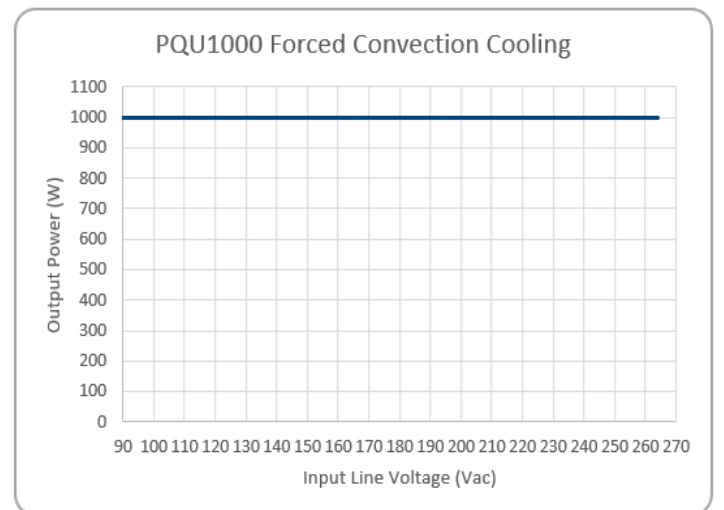

- No derating with input line voltage for convection or forced convection cooling airflow, for all series variants when cooled with top (cover) mounted fan.

CONNECTION DIAGRAM

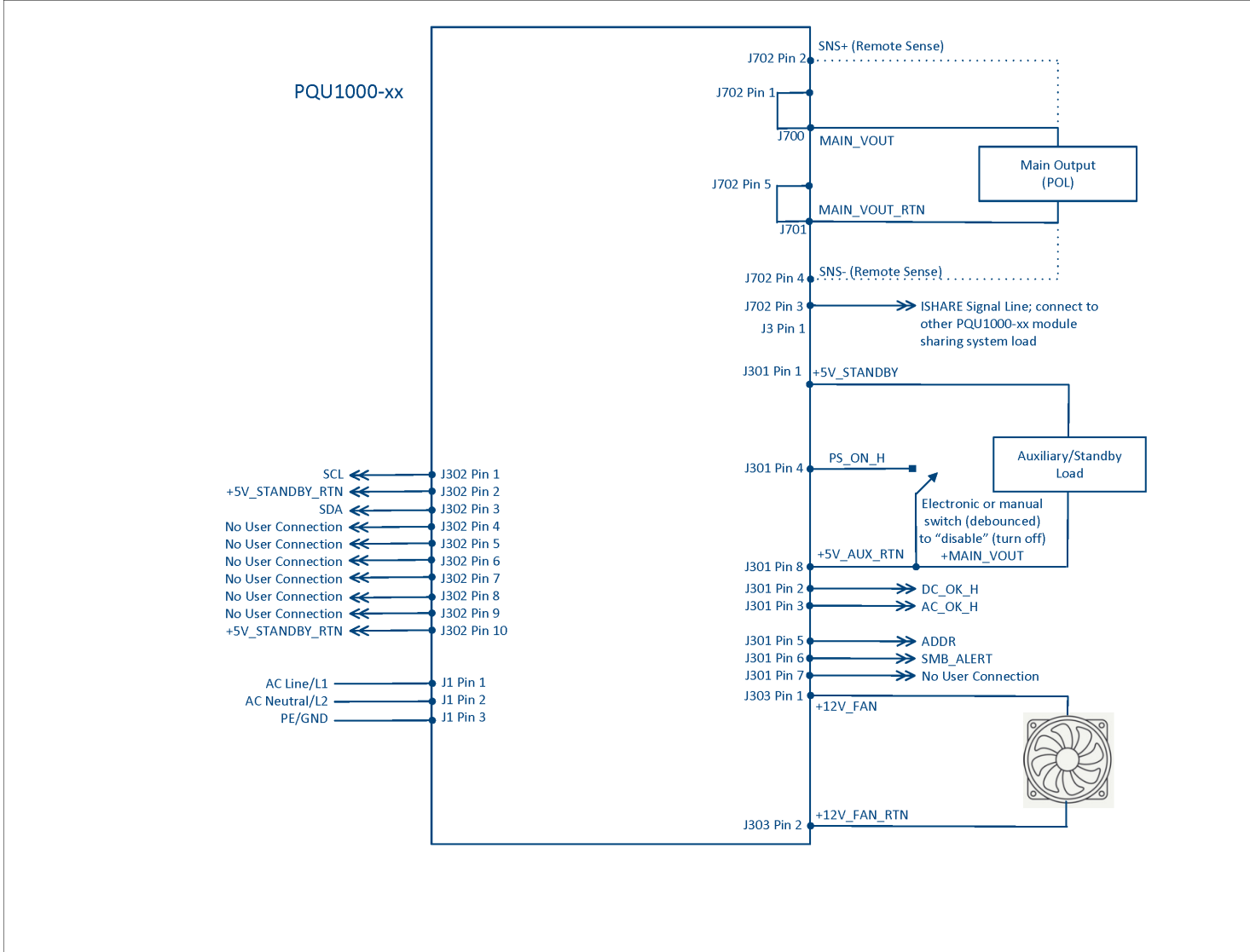

Note: For parallel (current share) operation, it is required to connect the sharing power supplies in parallel (+DC out connected together and DC out Return connected together) on sharing power supplies. The PQU1000 is provided with “active current share”. The ISHARE signal (found on J702 Pin 3) requires to be directly connected to each power sharing power module, to create an ISHARE signal bus.

Connections should be as short as possible and avoid any areas of areas containing strong magnetic or electrical fields that could induce noise on to the ISHARE bus. It is recommended that for redundant (critical) applications that external isolation devices (diodes or MOSFETS) are employed.

MECHANICAL DIMENSIONS (NOMINAL)

PQU1000-xx "U" Channel Dimensions

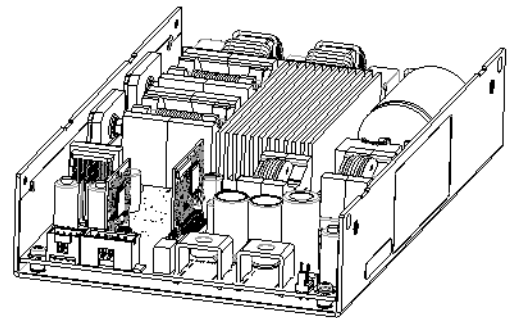
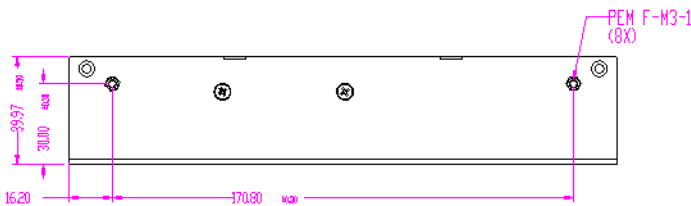
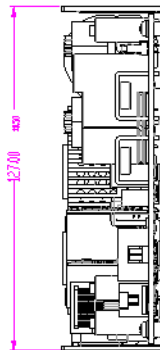
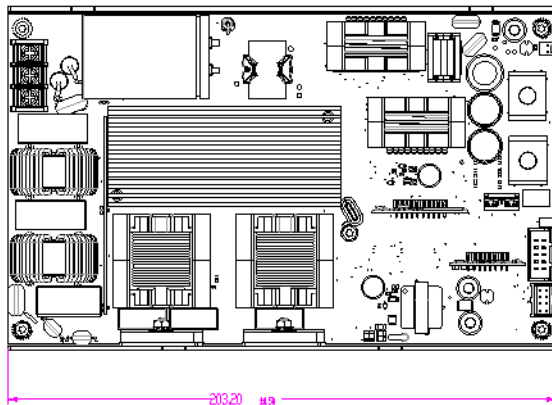
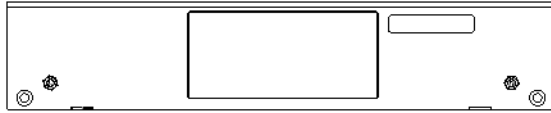

INPUT CONNECTOR J1

Dinkle Part# DT-35-B01W-03
Supported Cable Gauge: 22-12AWG; 0.34-4.0mm²
Torque screws not greater than 0.5Nm (4.4in lbs.)

Pin 1	AC Line/L1
Pin 2	AC Neutral/L2
Pin3	PE/GND

OUTPUT CONNECTOR J700, J701

SCED Part#: AO-15/4J-N5
High Current Electrical Screwed Terminals
Connectors 100A 10.0mm*16.5mm

J700	MAIN_VOUT
J701	MAIN_VOUT_RTN

VSTANDBY & SIGNAL CONNECTOR: J301

PCB Connector: Molex 90130-1108
Mating Part: Molex 0901420008 (housing) + Molex 901190109 (crimp)

Pin 1	+5V_STANDBY
Pin 2	PWR_OK
Pin 3	AC_OK
Pin 4	PS_ON_H
Pin 5	ADDR
Pin 6	SMB_ALERT
Pin 7	N/C
Pin 8	+5V_STANDBY_RTN

PMBUS™ CONNECTOR; J302	
PCB Connector:	
<ul style="list-style-type: none"> Amphenol G821EU210AGM00Y Mating Connector; 3M 89110-010HA 	
Pin 1	SCL
Pin 2	+5V_STANDBY_RTN
Pin 3	SDA
Pin 4	N/C
Pin 5	N/C
Pin 6	N/C
Pin 7	N/C
Pin 8	N/C
Pin 9	N/C
Pin 10	+5V_STANDBY_RTN

EXTERNAL FAN CONNECTOR; J303	
PCB Connector:	
<ul style="list-style-type: none"> TE Connectivity; 640456-2 Mating Connector: Molex 22-23-2021 	
Pin 1	+12V_FAN
Pin 2	+12_FAN_RTN

REMOTE SENSE & ISHARE CONNECTOR; J702	
PCB Connector:	
<ul style="list-style-type: none"> TE Connectivity; 640456-5 Mating Connector: Molex 22-23-2051 	
Pin 1	MAIN_VOUT
Pin 2	SNS+
Pin 3	ISHARE
Pin 4	SNS-
Pin 5	MAIN_VOUT_RTN

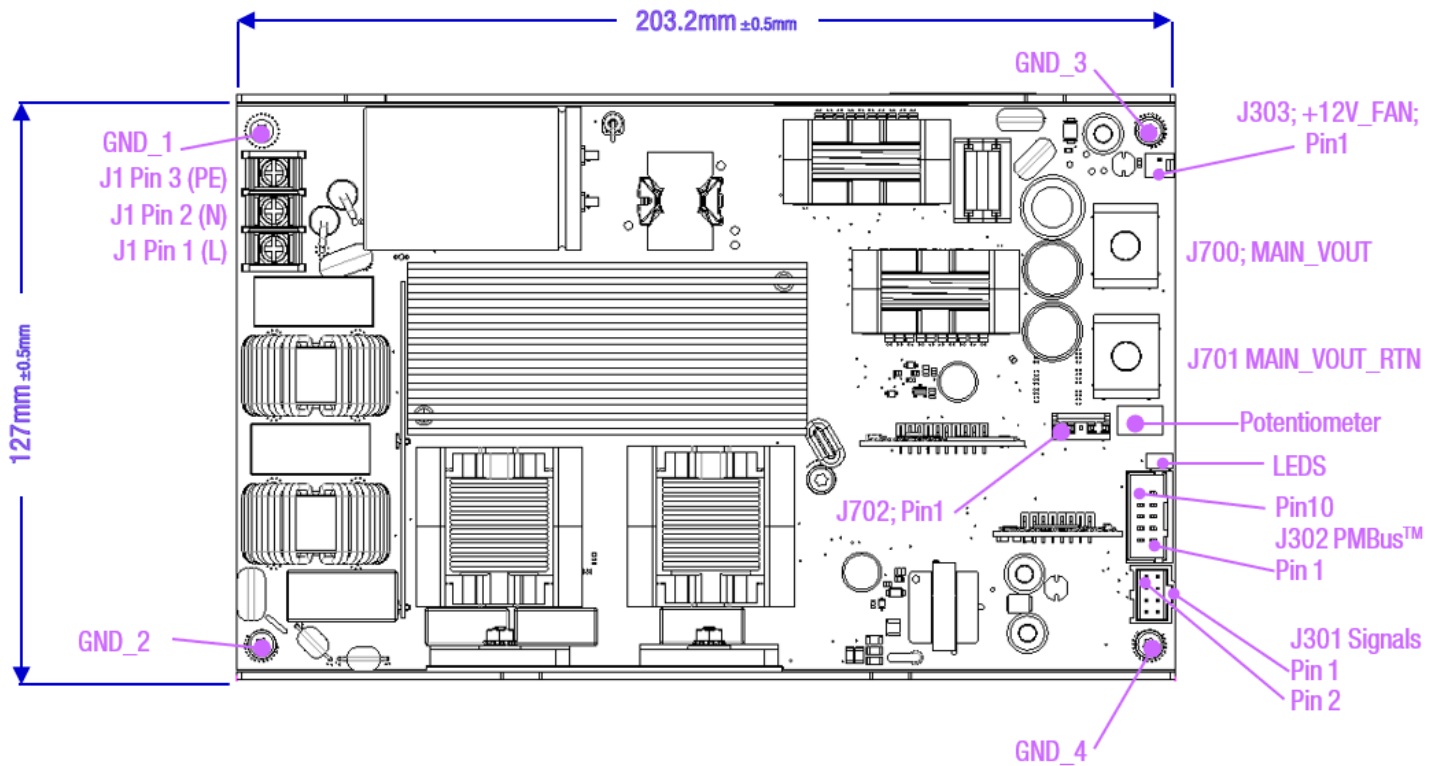

MECHANICAL DIMENSIONS (NOMINAL)

PQU1000-xx WITH PQU1000-Cover Assembly

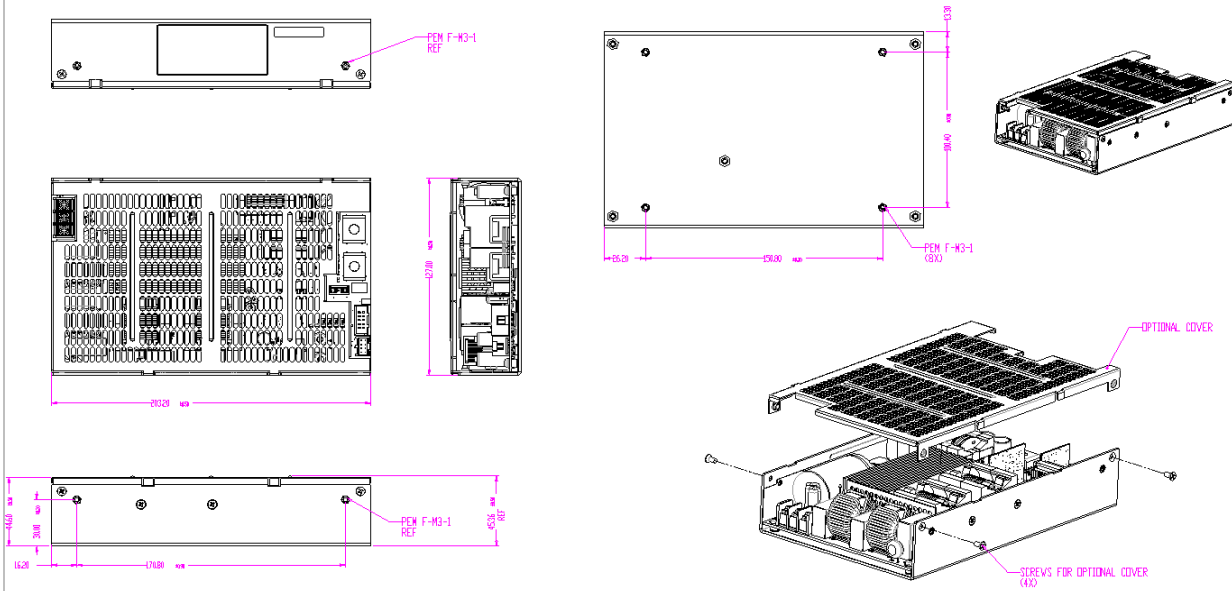

MECHANICAL DIMENSIONS (NOMINAL)

PQU1000-xx WITH PQU1000-FT-Cover - Top Mounted Fan Assembly

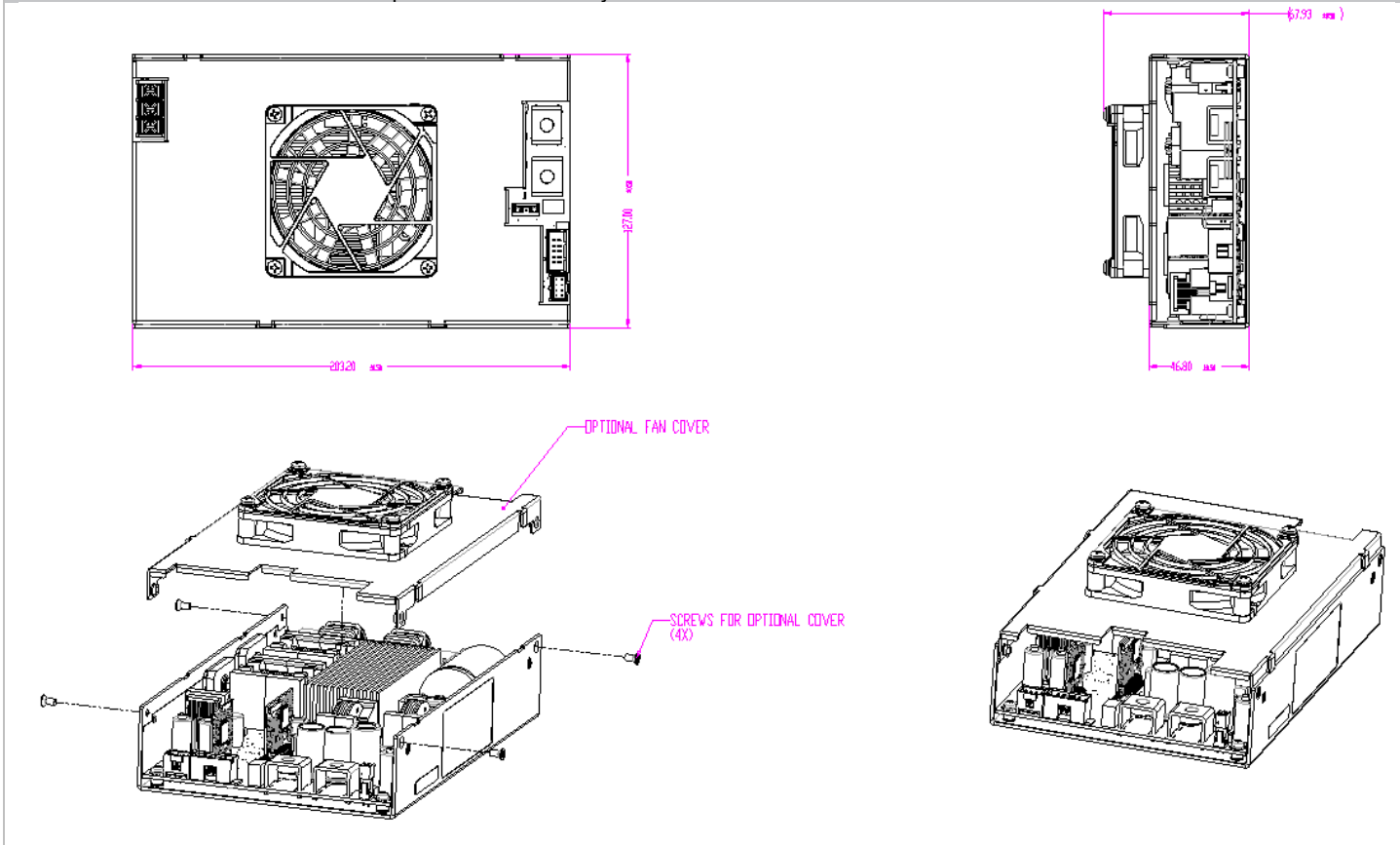

SAFETY CONSIDERATIONS



- 1 This power supply is a component level power supply intended for use in Class I applications intended for the connection of PE (Protective Earth).
- 2 A protective bonding conductor from the end product protective earthing terminal must be tied to connector J1 (relevant pin dependent on connector type).
- 3 The primary heatsink is considered a live primary circuit and should not be touched. It is recommended that the primary heatsink be kept at least 4mm from chassis/ground and 8mm from secondary (SELV) circuitry. In all cases, the applicable safety standards must be applied to ensure proper creepage and clearance requirements are met.
- 4 This product is subject to the following operating requirements and the Life and Safety Critical Application Sales Policy: <https://www.murata.com/products/power/requirements/>
- 5 The power supply has been evaluated for 5000m altitude and tropical climatic conditions for China.
- 6 Double pole/neutral input source fusing is used; the product label is annotated accordingly.
- 7 If the product is used with the PQU1000 cover assemblies. the relevant safety creepage and clearance requirements are preserved when the PQU1000 if so installed.
- 8 For all deployment where installed chassis mounting screws are used, the End User should ensure that the screw does not protrude by more than two (2) threads through the captive PEM mounted in the "U" channel.

ACCESSORIES APPLICATION NOTES*

Document	Description	Document Name
ACAN-127	PQU1000 Current Sharing/External ORING deployment notes	ACAN-127
ACAN-128	PQU1000 Installation/Thermal deployment notes	ACAN-128
ACAN-129	PMBus™ Protocol Feature Set	ACAN-129
PQU1000-COVER	Cover Kit datasheet	PQU1000-COVER Datasheet
PQU1000-FT-COVER	Cover Kit; Top Mounted Fan datasheet	PQU1000-FT-COVER Datasheet

*Consult the sales channel for availability of ACAN documents.

Murata Power, Inc.
129 Flanders Road
Westborough, MA 01581 USA
ISO 9001 and 14001 REGISTERED



This product is subject to the following operating requirements and the Life and Safety Critical Application Sales Policy: Refer to: <https://www.murata.com/products/power/requirements/>
Murata Power, Inc. makes no representation that the use of its products in the circuits described herein, or the use of other technical information contained herein, will not infringe upon existing or future patent rights. The descriptions contained herein do not imply the granting of licenses to make, use, or sell equipment constructed in accordance therewith. Specifications are subject to change without notice.

©2024 Murata Power, Inc.