

CHIP COMMON MODE CHOKE COIL for Consumer equipment DLM0NS□□□□HY2□ Reference Specification

1. Scope

This reference specification applies to Chip Common Mode Choke Coil DLM0NS_HY2 Series for differential signal interface in Electronics.

1.1 Specific applications:

- Consumer equipment: Products that can be used in consumer equipment such as home appliances, audio/visual equipment, communication equipment, information equipment, office equipment, and household robotics, and whose functions are not directly related to the protection of human life and property.
- Medical equipment (GHTF Class C) *Except for implant/surgery/auto injector: Products that can be used for medical equipment of Class C of the international classification class GHTF and whose malfunction is considered to pose a relatively high risk to the human body.
- Medical equipment (GHTF Class A and B): Products that can be used for medical equipment regulated by Class A and Class B of the international classification class GHTF and whose functions do not directly relate to the protection of human life and property.
- Industrial equipment: Products that can be used in industrial equipment such as base stations, manufacturing equipment, industrial robotics equipment, and measurement equipment, and whose functions do not directly relate to the protection of human life and property.

1.2 Unsuitable application:

Applications listed in "Limitation of applications" in this reference specification.

WE DISCLAIM ANY LOSS AND DAMAGES ARISING FROM OR IN CONNECTION WITH THE PRODUCTS INCLUDING BUT NOT LIMITED TO THE CASE SUCH LOSS AND DAMAGES CAUSED BY THE UNEXPECTED ACCIDENT, IN EVENT THAT THE PRODUCT IS APPLIED FOR THE PURPOSE WHICH IS SPECIFIED ABOVE AS THE UNSUITABLE APPLICATION FOR THE PRODUCT.

2. Part Numbering

(ex.) DL M 0N S B 120 H Y 2 D
 (1) (2) (3) (4) (5) (6) (7) (8) (9) (10)

- | | |
|---|---|
| (1) Chip Common Mode Choke Coil
(2) Structure (M : Monolithic Type)
(3) Dimension (L×W)
(4) Type S: Magnetically shielded one circuit type
(5) Category | (6) Impedance (Typ. at 100MHz)
(7) Circuit H : Characteristic Impedance 100Ω system
(8) Features
(9) Number of Line
(10) Packaging Code D : Taping / B : Bulk |
|---|---|

3. Rating

Customer Part Number	Murata Part Number	Common Mode Impedance (at 100MHz, Under Standard Testing Condition)	Rated Voltage	Withstanding Voltage	Rated Current	DC Resistance	Insulation Resistance	Cut-off Frequency
	DLM0NSB120HY2D	12Ω ± 5Ω	5V(DC)	12.5V(DC)	160mA	1.2Ω ± 25%	10MΩ min.	8GHz(Typ.)
	DLM0NSB120HY2B				130mA			
	DLM0NSB280HY2D	28Ω ± 30%	5V(DC)	12.5V(DC)	100mA	1.9Ω ± 25%	10MΩ min.	5GHz(Typ.)
	DLM0NSB280HY2B				100mA			
	DLM0NSN500HY2D	50Ω ± 25%	5V(DC)	12.5V(DC)	100mA	2.7Ω ± 25%	10MΩ min.	5GHz(Typ.)
	DLM0NSN500HY2B							
	DLM0NSN900HY2D	90Ω ± 25%	5V(DC)	12.5V(DC)	100mA	4.0Ω ± 25%	10MΩ min.	2GHz(Typ.)
	DLM0NSN900HY2B							
	DLM0NSM900HY2D	90Ω ± 25%	5V(DC)	12.5V(DC)	100mA	3.8Ω ± 25%	10MΩ min.	5GHz(Typ.)
	DLM0NSM900HY2B							

Operating Temperature : -40 to +85°C

Storage Temperature : -40 to +85°C

4. Standard Testing Conditions

<Unless otherwise specified>
 Temperature : Ordinary Temperature 15 to 35°C
 Humidity : Ordinary Humidity 25 to 85%(RH)

<In case of doubt>
 Temperature : 20 ± 2°C
 Humidity : 60 to 70%(RH)
 Atmospheric Pressure : 86 to 106kPa

5. Style and Dimensions

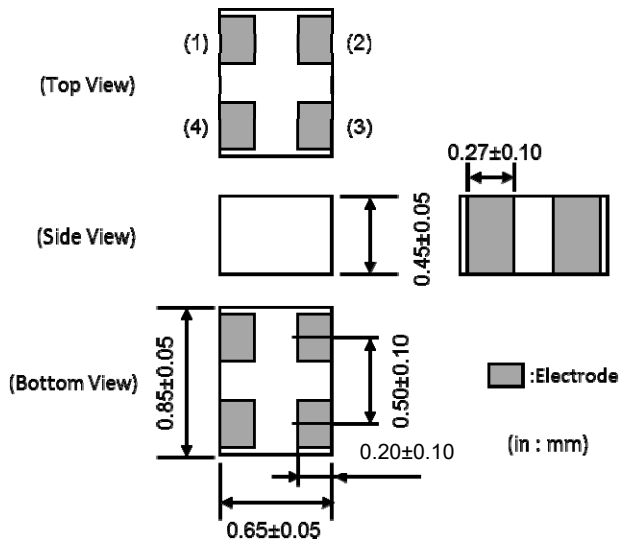

■ Equivalent Circuits

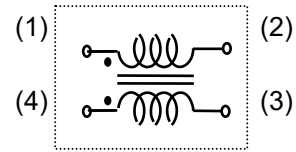

No polarity

■ Unit Mass(Typical value)

0.9mg

6. Marking

No Marking.

7. Electrical Performance

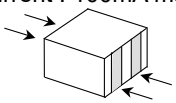
No.	Item	Specification	Test Method
7.1	Common Mode Impedance	Meet item 3.	Measuring Frequency : 100 ± 1 MHz (ref.item 10.) Measuring Equipment : KEYSIGHT 4291A or the equivalents (In case of doubt in standard condition, the heat treatment(200°C, about 10 min) shall be applied.
7.2	Withstanding Voltage	Products shall not be damaged.	Test Voltage : 2.5 times for Rated Voltage Time : 1 to 5s Charge Current : 1 mA max.(ref.item 10.)
7.3	DC Resistance (Rdc)	Meet item 3.	Measuring current : 100mA max.(ref.item 10.) 
7.4	Insulation Resistance (I.R.)		Measuring voltage : Rated Voltage Measuring time : 1 min max. (ref.item 10.)

8. Mechanical Performance

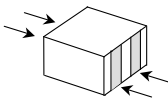
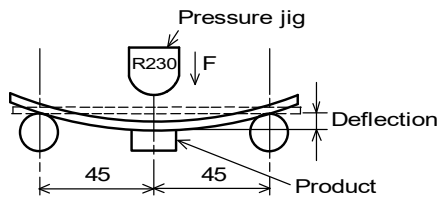
No.	Item	Specification	Test Method						
8.1	Appearance and Dimensions	Meet item 5.	Visual Inspection and measured with Slide Calipers.						
8.2	Solderability	The electrodes shall be at least 95% covered with new solder coating. 	Flux : Ethanol solution of rosin, 25(wt)% Pre-Heating : 150±10°C, 60~90s Solder : Sn-3.0Ag-0.5Cu Solder Temperature : 230±3°C Immersion Time : 3±0.5s Immersion and emersion rates : 25 mm / s						
8.3	Resistance to Soldering Heat	Meet Table 1. <table border="1" style="width: 100%; border-collapse: collapse;"> <tr> <td>Appearance</td> <td>No damaged</td> </tr> <tr> <td>Common Mode Impedance Change</td> <td>within ± 30%</td> </tr> <tr> <td>I.R.</td> <td>10MΩ min.</td> </tr> </table>	Appearance	No damaged	Common Mode Impedance Change	within ± 30%	I.R.	10MΩ min.	Flux : Ethanol solution of rosin, 25(wt)% Pre-Heating : 150±10°C, 60~90s Solder : Sn-3.0Ag-0.5Cu Solder Temperature : 270±5°C Immersion Time : 5±1s Immersion and emersion rates : 25 mm / s Then measured after exposure in the room condition for 4h to 48h.
Appearance	No damaged								
Common Mode Impedance Change	within ± 30%								
I.R.	10MΩ min.								
8.4	Drop	<table border="1" style="width: 100%; border-collapse: collapse;"> <tr> <td>DC Resistance Change</td> <td>within ± 30%</td> </tr> </table>	DC Resistance Change	within ± 30%	It shall be dropped on concrete or steel board. Method : free fall Height : 1m The Number of Times : 10 times				
DC Resistance Change	within ± 30%								
8.5	Vibration		It shall be soldered on the substrate. Oscillation Frequency : 10 to 2000 for 20 min Total amplitude : 3.0 mm or Acceleration amplitude 196 m/s ² whichever is smaller. Testing Time : A period of 4 hours in each of 3 mutually perpendicular directions.						
8.6	Bending Strength	Meet Table 2. <table border="1" style="width: 100%; border-collapse: collapse;"> <tr> <td>Appearance</td> <td>No damaged</td> </tr> <tr> <td>DC Resistance Change</td> <td>within ± 30%</td> </tr> </table>	Appearance	No damaged	DC Resistance Change	within ± 30%	Substrate : (t = 1.0 mm). Deflection : 2 mm Speed of Applying Force : 1.0 mm / s Keeping time : 60s 		
Appearance	No damaged								
DC Resistance Change	within ± 30%								

Reference Only

Spec No. JEFL243D-0009P-01

P4/12

9. Environmental Performance (Products shall be soldered on the glass-epoxy substrate)

No.	Item	Specification	Test Method
9.1	Temperature Cycle	Meet Table 1.	1 Cycle Step 1 -40°C(+0°C,-3°C) / 30(+3,-0) min Step 2 Ordinary Temp. / within 3 min Step 3 +85(+2°C,-0°C) / 30(+3,-0) min Step 4 Ordinary Temp. / within 3 min Total of 100 cycles. Then measured after exposure in the room condition for 4h to 48h.
9.2	Humidity		Temperature : 40±2°C Humidity : 90 to 95 % (RH) Time : 1000h (+48h,-0h) Then measured after exposure in the room condition for 4h to 48h.
9.3	Heat life		Temperature : 85±2°C Test Voltage : 2 times for Rated Voltage Time : 1000h (+48h,-0h) Then measured after exposure in the room condition for 4h to 48h. (ref. Item 10.)
9.4	Cold Resistance		Temperature : -40± 2°C Time : 1000h (+48h,-0h) Then measured after exposure in the room condition for 4h to 48h.

10. Terminal to be Tested.

When measuring and supplying the voltage, the following terminal is applied.

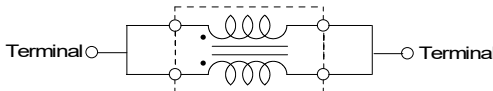
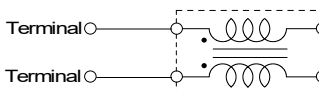
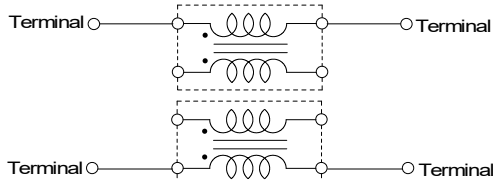
No.	Item	Terminal to be Tested
10.1	Common Mode Impedance	
10.2	Withstanding Voltage Insulation Resistance Heat Life	
10.3	DC Resistance	

11. Measuring method for common mode impedance.

Measured common mode impedance may be included measurement error due to stray capacitance, residual inductance of test fixture.

To correct this error, the common mode impedance should be calculate as follows;

- (1) Measure admittance of the fixture(opened), G_o B_o .
- (2) Measure impedance of the fixture(shorted), R_s X_s .
- (3) Measure admittance of the specimen, G_m B_m .
- (4) Calculate corrected impedance $|Z|$ using the formula below.

$$|Z| = (R_x^2 + X_x^2)^{1/2}$$

Where

$$R_x = \frac{G_m - G_o}{(G_m - G_o)^2 + (B_m - B_o)^2} - R_s$$

$$X_x = \frac{-(B_m - B_o)}{(G_m - G_o)^2 + (B_m - B_o)^2} - X_s$$

12. P.C.B., Flux, Solder and Soldering condition

Test shall be done using P.C.B., Flux, Solder and Soldering condition which are specified in item 16 except the case of being specified special condition.

13. Impedance Frequency Characteristics (Typical)

DLM0NSB120HY2

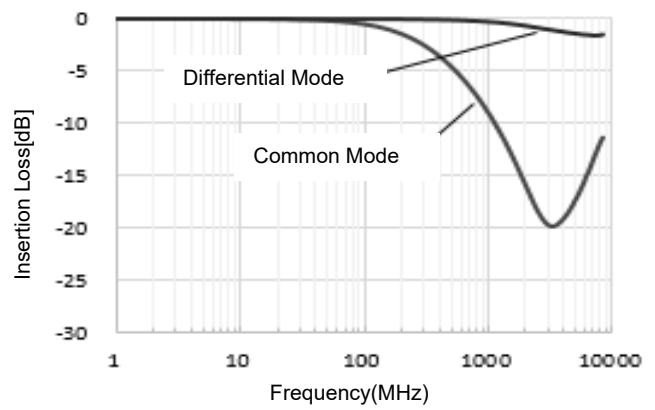
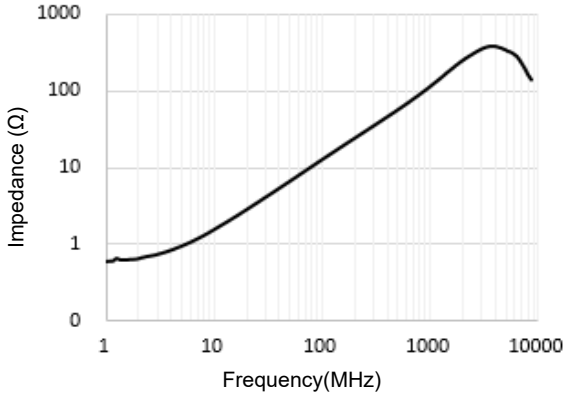

DLM0NSB280HY2

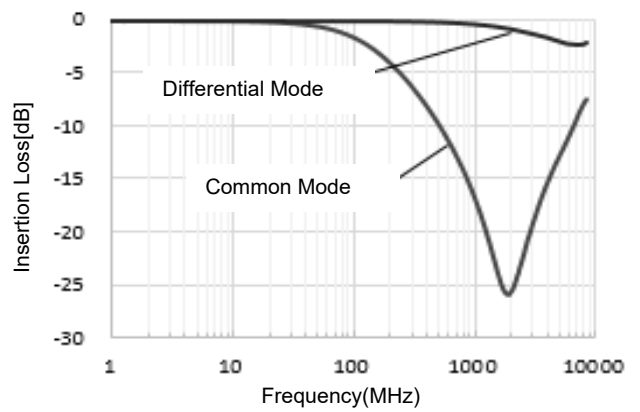
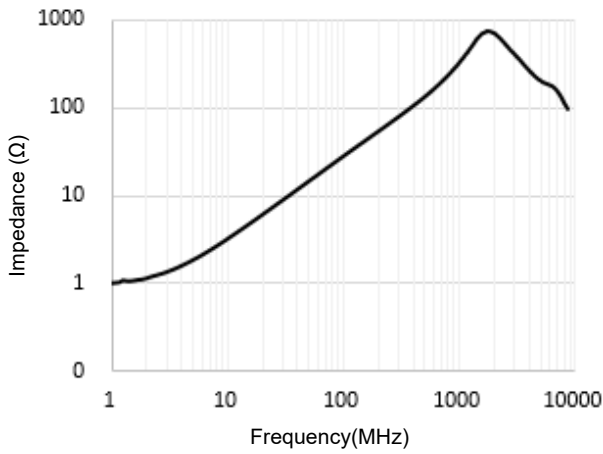

DLM0NSN500HY2

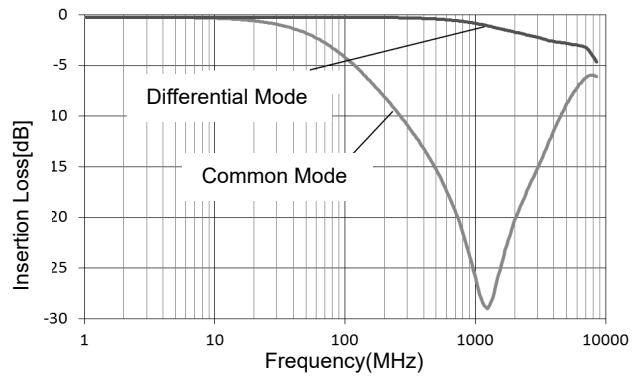
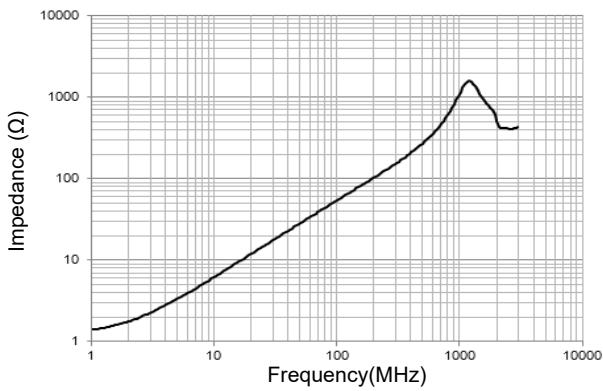

DLM0NSN900HY2

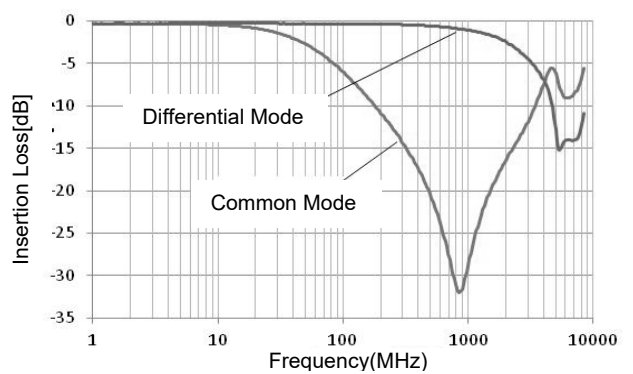
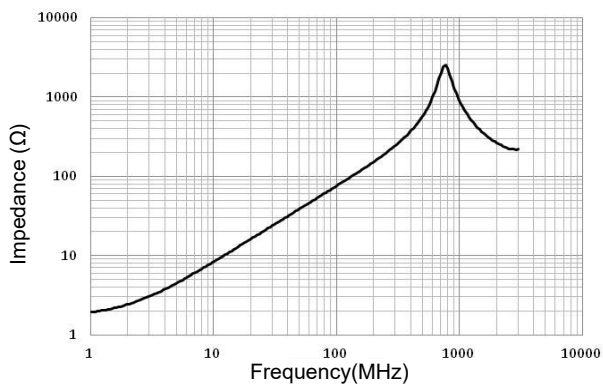

DLM0NSM900HY2

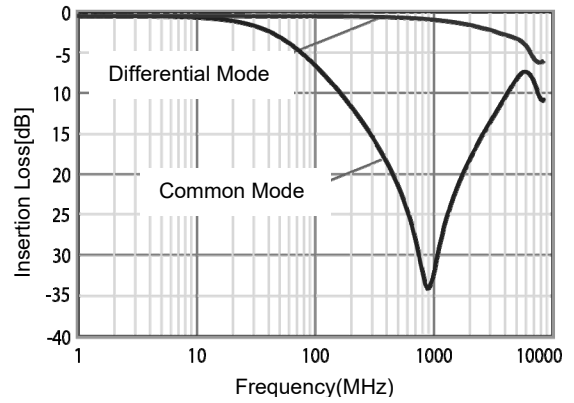
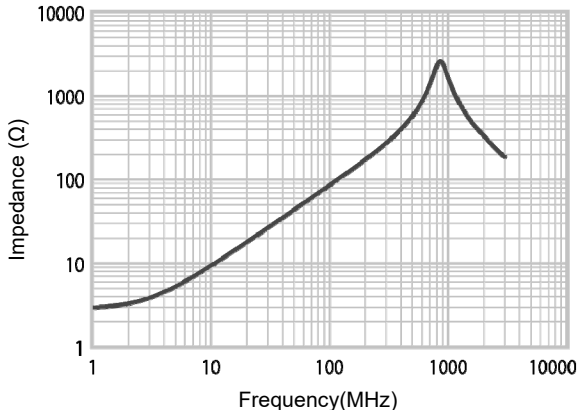

14. Specification of Packaging Frequency

14.1 Appearance and Dimensions (8mm-wide, 2mm pitch Paper tape)

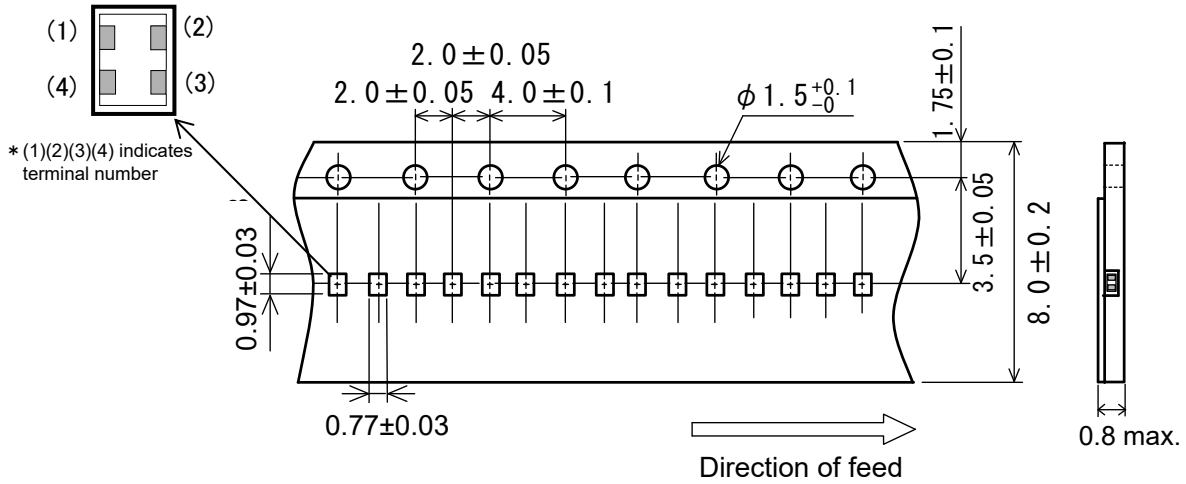

(in:mm)

14.2 Specification of Taping

- (1)Packing quantity(Standard quantity) 10,000 pcs. / reel
- (2)Packing Method
Products shall be packed in the cavity of the base tape and sealed by Cover tape.
- (3)Sprocket Hole
The sprocket holes are to the right as the tape is pulled toward the user.
- (4)Spliced point
The cover tape have no spliced point.
- (5)Missing components number
Missing components number within 0.1% of the number per reel or 1 pc., whichever is greater, and are not continuous. The specified quantity per reel is kept.

14.3 Pull Strength of Paper Tape

Paper Tape	5N min.
Cover Tape	10N min.

14.4 Peeling off force of Cover Tape

0.1 to 0.6N(Minimum value is Typical)
Speed of Peeling off : 300 mm/min.

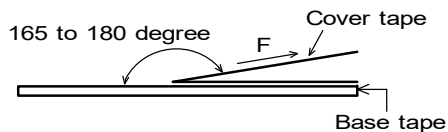

14.5 Dimensions of Leader-tape, Trailer and Reel

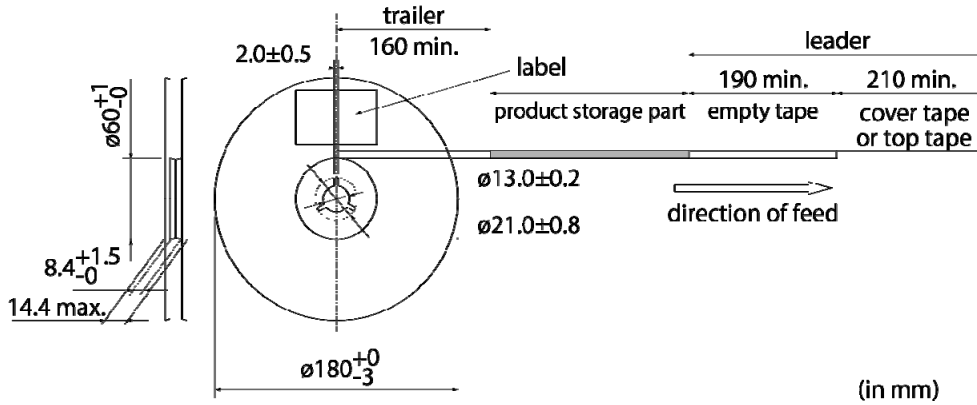

14.6 Marking for reel

Customer part number, MURATA part number, Inspection number(*1), RoHS marking(*2), Quantity, etc

*1) « Expression of Inspection No. »

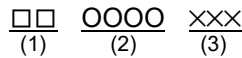

- (1) Factory Code
- (2) Date

First digit : Year / Last digit of year
 Second digit : Month / Jan. to Sep. → 1 to 9, Oct. to Dec. → O, N, D
 Third, Fourth digit : Day

- (3) Serial No.

*2) « Expression of RoHS marking »

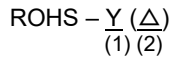

- (1) RoHS regulation conformity parts.
- (2) MURATA classification number

14.7 Marking for Outside package

Customer name Purchasing Order Number, Customer Part Number, MURATA part number, RoHS marking(*2), Quantity, etc

14.8 Specification of Outer Case

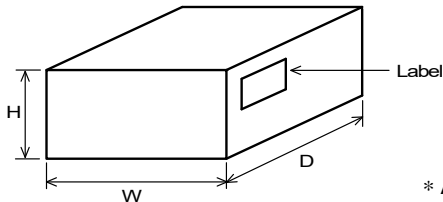

Outer Case Dimensions (mm)			Standard Reel Quantity in Outer Case (Reel)
W	D	H	
186	186	93	5

* Above Outer Case size is typical. It depends on a quantity of an order.

15. ⚠ Caution

15.1 Mounting Direction

Mount products in right direction.

Wrong direction which is 90° rotated from right direction causes not only open or short circuit but also flames or other serious trouble.

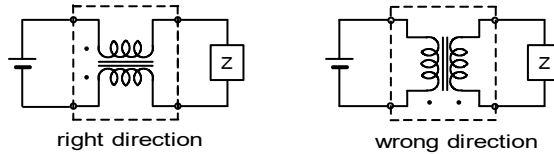

15.2 Limitation of Applications

The products listed in the reference specification (hereinafter the product(s) is called as the “Product(s)”) are designed and manufactured for applications specified in the reference specification (hereinafter called as the “Specific Application”).

We shall not warrant anything in connection with the Products including fitness, performance, adequateness, safety, or quality, in the case of applications listed in from (1) to (11) written at the end of this precautions, which may generally require high performance, function, quality, management of production or safety. Therefore, the Product shall be applied in compliance with the specific application.

WE DISCLAIM ANY LOSS AND DAMAGES ARISING FROM OR IN CONNECTION WITH THE PRODUCTS INCLUDING BUT NOT LIMITED TO THE CASE SUCH LOSS AND DAMAGES CAUSED BY THE UNEXPECTED ACCIDENT, IN EVENT THAT (i) THE PRODUCT IS APPLIED FOR THE PURPOSE WHICH IS NOT SPECIFIED AS THE SPECIFIC APPLICATION FOR THE PRODUCT, AND/OR (ii) THE PRODUCT IS APPLIED FOR ANY FOLLOWING APPLICATION PURPOSES FROM (1) TO (11) (EXCEPT THAT SUCH APPLICATION PURPOSE IS UNAMBIGUOUSLY SPECIFIED AS SPECIFIC APPLICATION FOR THE PRODUCT IN OUR CATALOG SPECIFICATION FORMS, DATASHEETS, OR OTHER DOCUMENTS OFFICIALLY ISSUED BY US*).

- (1) Aircraft equipment
- (2) Aerospace equipment
- (3) Undersea equipment
- (4) Power plant control equipment
- (5) Medical equipment
- (6) Transportation equipment
- (7) Traffic control equipment
- (8) Disaster prevention/security equipment
- (9) Industrial data-processing equipment
- (10) Combustion/explosion control equipment
- (11) Equipment with complexity and/or required reliability equivalent to the applications listed in the above.

For exploring information of the Products which will be compatible with the particular purpose other than those specified in the reference specification please contact our sales offices, distribution agents, or trading companies with which you make a deal, or via our web contact form.

Contact form: <https://www.murata.com/contactform>

* We may design and manufacture particular Products for applications listed in (1) to (11). Provided that, in such case we shall unambiguously specify such Specific Application in the reference specification without any exception. Therefore, any other documents and/or performances, whether exist or non-exist, shall not be deemed as the evidence to imply that we accept the applications listed in (1) to (11).

15.3 Corrosive gas

Please refrain from use since contact with environments with corrosive gases (sulfur gas [hydrogen sulfide, sulfur dioxide, etc.], chlorine, ammonia, etc.) or oils (cutting oil, silicone oil, etc.) that have come into contact with the previously stated corrosive gas environment will result in deterioration of product quality or an open from deterioration due to corrosion of product electrode, etc. We will not bear any responsibility for use under these environments.

16. Notice

This product is designed for solder mounting. (reflow soldering only)

Please consult us in advance for applying other mounting method such as conductive adhesive.

16.1 Flux and Solder

Flux	Use rosin-based flux, but not highly acidic flux (with chlorine content exceeding 0.2(wt)% .) Do not use water-soluble flux.
Solder	Use Sn-3.0Ag-0.5Cu solder Use of Sn-Zn based solder will deteriorate performance of products. In case of using Sn-Zn based solder, please contact Murata in advance.

16.2 Assembling

<Thermal Shock>

Pre-heating should be in such a way that the temperature difference between solder and ceramic surface is limited to 100°C MAX. Also cooling into solvent after soldering should be in such a way that the temperature difference is limited to 100°C max.

16.3 Resin coating

The impedance value may change and/or it may affect on the product's performance due to high cure-stress of resin to be used for coating / molding products. So please pay your careful attention when you select resin. In prior to use, please make the reliability evaluation with the product mounted in your application set.

16.4 Attention regarding P.C.B. bending

The following shall be considered when designing and laying out P.C.B.'s.

- (1) P.C.B. shall be designed so that products are not subject to the mechanical stress due to warping the board.

[Products direction]

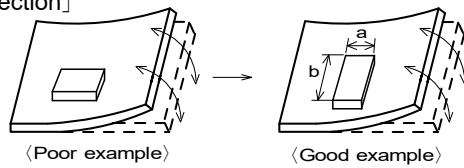

Products shall be located sideways Direction (Length : $a < b$) to the mechanical Stress.

[Warping direction]

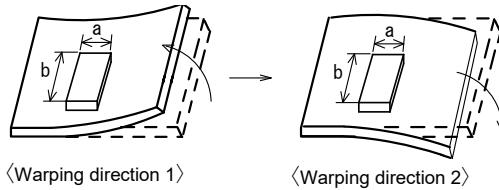

Products(warping direction 1, warping direction 2) shall be located carefully so that products are not subject to the mechanical stress due to warping the board. Because they may be subjected the mechanical stress in order of warping direction 1 > warping direction 2.

- (2) Components location on P.C.B. separation

It is effective to implement the following measures, to reduce stress in separating the board.

It is best to implement all of the following three measures; however, implement as many measures as possible to reduce stress.

Contents of Measures	Stress Level
(1) Turn the mounting direction of the component parallel to the board separation surface.	A > D *1
(2) Add slits in the board separation part.	A > B
(3) Keep the mounting position of the component away from the board separation surface.	A > C

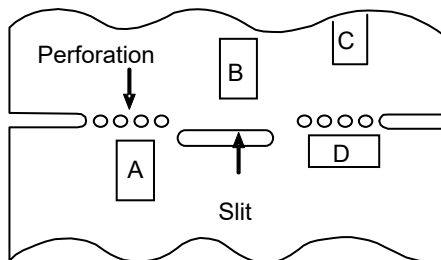

*1 A > D is valid when stress is added vertically to the perforation as with Hand Separation. If a Cutting Disc is used, stress will be diagonal to the PCB, therefore A > D is invalid.

- (3) Mounting Components Near Screw Holes

When a component is mounted near a screw hole, it may be affected by the board deflection that occurs during the tightening of the screw. Mount the component in a position as far away from the screw holes as possible.

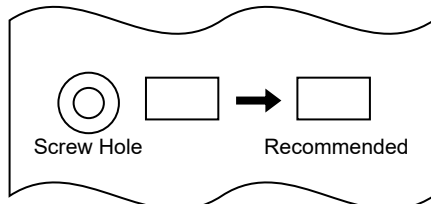

16.5 Attention Regarding P.C.B. Design

< The Arrangement of Products >

P.C.B. shall be designed so that products are far from the portion of perforation.

The portion of perforation shall be designed as narrow as possible, and shall be designed so as not to be applied the stress in the case of P.C.B. separation.

Products shall not be arranged on the line of a series of holes when there are big holes in P.C.B.
(Because the stress concentrate on the line of holes.)

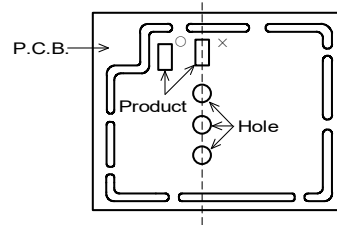
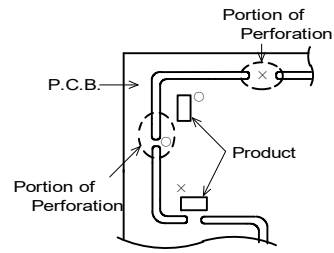

< Products Placing >

Support pins shall be set under P.C.B. to prevent causing a warp to P.C.B. during placing the products on the other side of P.C.B.

< P.C.B. Separation >

P.C.B. shall not be separated with hand.
P.C.B. shall be separated with the fixture so as not to cause P.C.B. bending.

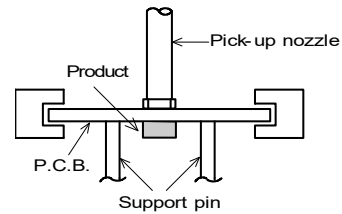

16.6 Attention Regarding P.C.B. Mounting

In case of mounting by use of mounting machine, please choose nozzle which can pick up components of 0603 size.

16.7 Standard Land Dimensions

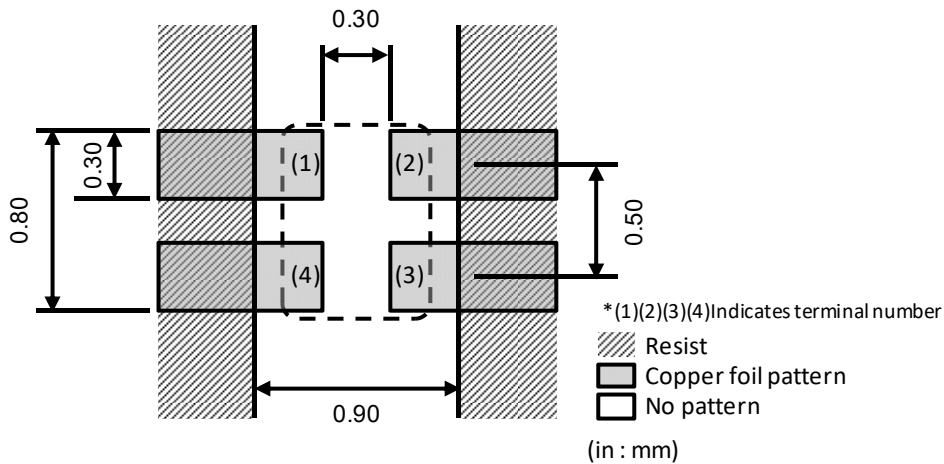

16.8 Soldering(Reflow soldering)

Standard soldering profile and the limit soldering profile is as follows.

The excessive limit soldering conditions may cause leaching of the electrode and / or resulting in the deterioration of product quality.

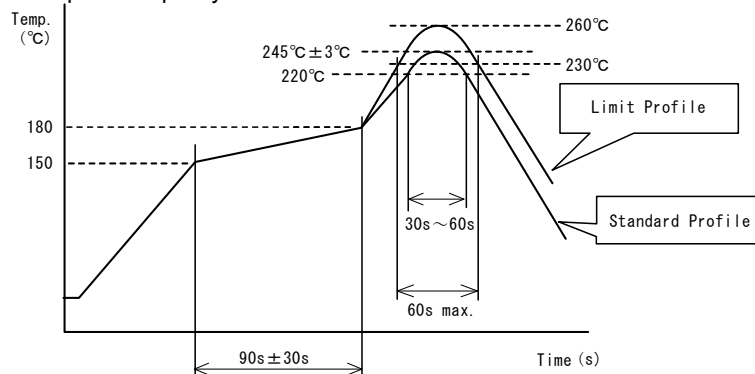

	Standard Profile	Limit Profile
Pre-heating	150~180°C、90s±30s	
Heating	above 220°C、30s~60s	above 230°C、60s max.
Peak temperature	245±3°C	260°C、10s
Cycle of reflow	2 times	2 times

(1) Standard printing pattern of solder paste

- Standard thickness of the solder paste should be 100 to 150µm.
- Use the solder paste printing pattern of the right pattern.
- For the resist and copper foil pattern, use standard land dimensions.
- Use Sn-3.0Ag-0.5Cu solder.

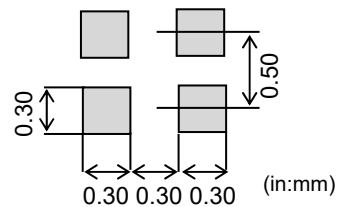

(2) Reworking with Soldering iron

- The following conditions shall be strictly followed when using a soldering iron after being mounted by reflow soldering.
 - Pre-heating: 150°C, 1 min
 - Tip temperature: 380°C max.
 - Soldering time : 3(+1,-0) seconds.
 - Soldering iron output: 30W max.
 - Tip diameter: φ3mm max.
 - Times : 2times max.
- Do not touch the products directly with the tip of the soldering iron.

(3) Solder Volume

Solder shall be used not to be exceeded the upper limits as shown below.

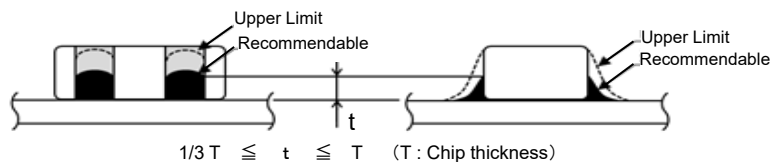

Accordingly increasing the solder volume, the mechanical stress to product is also increased. Excessive solder volume may cause the failure of mechanical or electrical performance.

16.9 Cleaning Conditions

Products shall be cleaned on the following conditions.

- Cleaning temperature shall be limited to 60°C max. (40°C max. for Isopropyl alcohol.)
- Ultrasonic cleaning shall comply with the following conditions, avoiding the resonance phenomenon at the mounted products and P.C.B..
 - Power : 20W/l max.
 - Frequency : 28kHz to 40kHz
 - Time : 5 min max.
- Cleaner
 - Alternative cleaner • Isopropyl alcohol (IPA)
 - Aqueous agent • PINE ALPHA ST-100S
- There shall be no residual flux and residual cleaner after cleaning.

In the case of using aqueous agent, products shall be dried completely after rinse with de-ionized water in order to remove the cleaner.
- Other cleaning

Please contact us.

16.10 Handling of a substrate

After mounting products on a substrate, do not apply any stress to the product caused by bending or twisting to the substrate when cropping the substrate, inserting and removing a connector from the substrate or tightening screw to the substrate.

Excessive mechanical stress may cause cracking in the product.

Bending

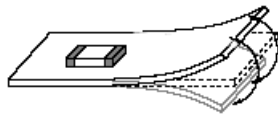

Twisting

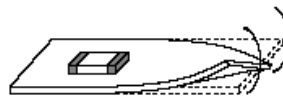

16.11 Operating Environment

Do not use this product under the following environmental conditions, on deterioration of the performance, such as insulation resistance may result from the use.

- (1) in the corrodible atmosphere such as acidic gases, alkaline gases, chlorine, sulfur gases, organic gases and etc (the sea breeze, Cl₂, H₂S, NH₃, SO₂, NO₂, etc)
- (2) in the atmosphere where liquid such as organic solvent, may splash on the products.

16.12 Storage Conditions

(1) Storage period

Use the products within 12 months after delivered.

Solderability should be checked if this period is exceeded.

(2) Storage environment condition

- Products should be stored in the warehouse on the following conditions.

Temperature : -10 to +40°C

Humidity : 15 to 85% relative humidity

No rapid change on temperature and humidity

- Products should not be stored in corrosive gases, such as sulfurous, acid gases, alkaline gases, to prevent the following deterioration.
 - Poor solderability due to the oxidized electrode.
- Products should be stored on the palette for the prevention of the influence from humidity, dust and so on.
- Products should be stored in the warehouse without heat shock, vibration, direct sunlight and so on.
- Avoid storing the product by itself bare (i.e. exposed directly to air).

(3) Delivery

Care should be taken when transporting or handling product to avoid excessive vibration or mechanical shock.

17. ⚠Note

- (1) Please make sure that your product has been evaluated in view of your specifications with our product being mounted to your product.
- (2) You are requested not to use our product deviating from the reference specifications.
- (3) The contents of this reference specification are subject to change without advance notice. Please approve our product specifications or transact the approval sheet for product specifications before ordering.