

**AgPd Termination Conductive Glue Mounting Chip Multilayer Ceramic Capacitors for Automotive Powertrain/Safety Equipment****■ Scope**

This specification is applied to Chip Multilayer Ceramic Capacitors limited to AgPd Termination Conductive Glue Mounting.

**1. Specific applications:**

- Automotive Powertrain/Safety Equipment: Products that can be used for automotive equipment related to running, turning, stopping, safety devices, etc., or equipment whose structure, equipment, and performance are legally required to meet technical standards for safety assurance or environmental protection.
- Automotive Infotainment/Comfort Equipment: Products that can be used for automotive equipment such as car navigation systems and car audio systems that do not directly relate to human life and whose structure, equipment, and performance are not specifically required by law to meet technical standards for safety assurance or environmental protection.
- Medial Equipment [GHTF A/B/C] except for Implant Equipment: Products suitable for use in medical devices designated under the GHTF international classifications as Class A or Class B (the functions of which are not directly involved in protection of human life or property) or in medical devices other than implants designated under the GHTF international classifications as Class C (the malfunctioning of which is considered to pose a comparatively high risk to the human body).

**2. Unsuitable Application: Applications listed in "Limitation of applications" in this specification.**

WE DISCLAIM ANY LOSS AND DAMAGES ARISING FROM OR IN CONNECTION WITH THE PRODUCTS INCLUDING BUT NOT LIMITED TO THE CASE SUCH LOSS AND DAMAGES CAUSED BY THE UNEXPECTED ACCIDENT, IN EVENT THAT THE PRODUCT IS APPLIED FOR THE PURPOSE WHICH IS SPECIFIED ABOVE AS THE UNSUITABLE APPLICATION FOR THE PRODUCT.

:Package

Product specifications in this catalog are as of Jul.8,2025, and are subject to change or obsolescence without notice.  
Please consult the approval sheet before ordering. Please read rating and !Cautions first.

<Reference> Please kindly use our website.  
Please refer to the product information page for more information on ceramic capacitors. [→ Ceramic capacitor product information](#)  
Various data can be obtained directly from the product search. [→ Product search \(SMD\)](#)

■ MURATA Part No. System

- (Ex.) 

|     |
|-----|
| GCG |
|-----|

|    |
|----|
| 32 |
|----|

|   |
|---|
| E |
|---|

|    |
|----|
| L8 |
|----|

|    |
|----|
| EG |
|----|

|     |
|-----|
| 106 |
|-----|

|   |
|---|
| K |
|---|

|     |
|-----|
| A07 |
|-----|

|   |
|---|
| L |
|---|
- ①Series      ②Dimension (LxW)      ③Dimension (T)      ④Temperature Characteristics      ⑤Rated Voltage      ⑥Capacitance      ⑦Capacitance Tolerance      ⑧Individual Specification      ⑨Package

■ Type & Dimension



image:Dimension

Size Code : 3225M(1210) (in mm)

| ② L       | ② W       | ③ T       | e        | g        |
|-----------|-----------|-----------|----------|----------|
| 3.2+/-0.4 | 2.5+/-0.3 | 2.5+/-0.3 | 0.3 min. | 1.0 min. |

Package

Rated Value

| ④Temperature Characteristics [L8]<br>(Public STD Code : [X8L(MURATA)]) |              |           | ⑤Rated Voltage | ⑥ Capacitance | ⑦ Capacitance Tolerance | Operating Temp. Range | Mounting Method |
|--|--------------|-----------|----------------|---------------|-------------------------|-----------------------|-----------------|
| Temp. coeff. or Cap. Change  | Temp. Range  | Ref.Temp. |                |               |                         |                       |                 |
| -40 to 15 %  | -55 to 150°C | 25°C      | DC 35V *       | 10μF          | +/-10%                  | -55 to 150°C          | Conductive glue |

\*Rated Voltage Derating:When the product temperature exceeds 125°C, please use this product within the voltage and temperature derated conditions in the figure below.

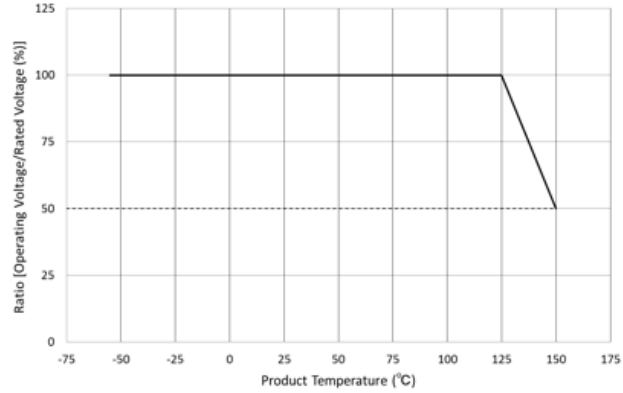

Fig:Dyrating

⑩Individual Specification : This denotes Murata control code.

Package

| ⑩Package | Packaging                     | Standard Packing Quantity |
|----------|-------------------------------|---------------------------|
| L        | φ180mm Reel Plastic Tape W8P4 | 1000 pcs./Reel            |
| K        | φ330mm Reel Plastic Tape W8P4 | 4000 pcs./Reel            |

■ Specifications and Test Methods

| No   | Item                                | Specification  | Test Method (Compliant Standard:AEC-Q200)   |      |           |           |   |                          |        |   |            |   |   |                          |        |   |            |   |
|------|-------------------------------------|--|---|------|-----------|-----------|---|--------------------------|--------|---|------------|---|---|--------------------------|--------|---|------------|---|
| 1    | AEC-Q200 Rev.                       | -  | Rev.D   |      |           |           |   |                          |        |   |            |   |   |                          |        |   |            |   |
| 2    | Pre-and Post-Stress Electrical Test | -  | -   |      |           |           |   |                          |        |   |            |   |   |                          |        |   |            |   |
| 3    | High Temperature Exposure (Storage) | Appearance No defects or abnormalities.<br>Capacitance Change Within +/-12.5%<br>Q or D.F. $DF \leq 0.03$<br>I.R.(Room Temp.) More than 500Ω · F | Mounting method Mount the capacitor on the test substrate using a conductive glue*.<br>*Conductive glue:HEREAUS"PC3000", Curing conditions:140°C/30min<br>Pre-treatment Heat treatment:Perform a heat treatment at 150+0/-10°C for 1hour and then let sit for 24+/-2hours at room temperature, then measure.<br>Test Temperature 150+/-3°C<br>Test Time 1000+/-12h<br>Post-treatment Non treatment:Let sit for 24+/-2hours at room temperature, then measure.   |      |           |           |   |                          |        |   |            |   |   |                          |        |   |            |   |
| 4    | Temperature Cycling                 | Appearance No defects or abnormalities.<br>Capacitance Change Within +/-10%<br>Q or D.F. $DF \leq 0.03$<br>I.R.(Room Temp.) More than 500Ω · F   | Mounting method Mount the capacitor on the test substrate using a conductive glue*.<br>*Conductive glue:HEREAUS"PC3000", Curing conditions:140°C/30min<br>Pre-treatment Heat treatment:Perform a heat treatment at 150+0/-10°C for 1hour and then let sit for 24+/-2hours at room temperature, then measure.<br>Cycles 300Cycles<br>Temperature Cycling <table border="1" data-bbox="1301 624 1771 754"> <thead> <tr> <th>Step</th> <th>Temp.(°C)</th> <th>Time(min)</th> </tr> </thead> <tbody> <tr> <td>1</td> <td>Min.Operating Temp.+0/-3</td> <td>30+/-3</td> </tr> <tr> <td>2</td> <td>Room Temp.</td> <td>1</td> </tr> <tr> <td>3</td> <td>Max.Operating Temp.+3/-0</td> <td>30+/-3</td> </tr> <tr> <td>4</td> <td>Room Temp.</td> <td>1</td> </tr> </tbody> </table><br>Post-treatment Non treatment:Let sit for 24+/-2hours at room temperature, then measure. | Step | Temp.(°C) | Time(min) | 1 | Min.Operating Temp.+0/-3 | 30+/-3 | 2 | Room Temp. | 1 | 3 | Max.Operating Temp.+3/-0 | 30+/-3 | 4 | Room Temp. | 1 |
| Step | Temp.(°C)                           | Time(min)  |   |      |           |           |   |                          |        |   |            |   |   |                          |        |   |            |   |
| 1    | Min.Operating Temp.+0/-3            | 30+/-3   |   |      |           |           |   |                          |        |   |            |   |   |                          |        |   |            |   |
| 2    | Room Temp.                          | 1  |   |      |           |           |   |                          |        |   |            |   |   |                          |        |   |            |   |
| 3    | Max.Operating Temp.+3/-0            | 30+/-3   |   |      |           |           |   |                          |        |   |            |   |   |                          |        |   |            |   |
| 4    | Room Temp.                          | 1  |   |      |           |           |   |                          |        |   |            |   |   |                          |        |   |            |   |
| 5    | Destructive Physical Analysis       | Appearance No defects or abnormalities.  | Per EIA-469   |      |           |           |   |                          |        |   |            |   |   |                          |        |   |            |   |

■ Specifications and Test Methods

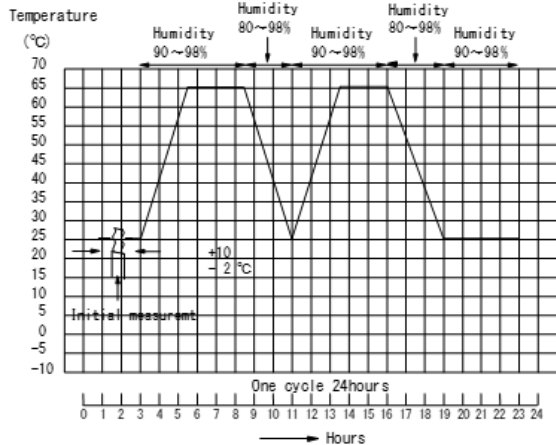
| No | Item                | Specification   |  | Test Method (Compliant Standard:AEC-Q200)  |  |
|----|---------------------|---|--|--|--|
| 6  | Moisture Resistance | Appearance<br>Capacitance Change<br>Q or D.F.<br>I.R.(Room Temp.) | No defects or abnormalities.<br>Within +/-12.5%<br>$DF \leq 0.03$<br>More than $500\Omega \cdot F$ | Mounting method<br>Pre-treatment<br>Test Temperature<br>Test Humidity<br>Test Time<br>Temperature and Humidity cycle                             | Mount the capacitor on the test substrate using a conductive glue*.<br>*Conductive glue:HEREAUS"PC3000", Curing conditions:140°C/30min<br>Heat treatment:Perform a heat treatment at 150+0/-10°C for 1 hour and then let sit for 24+/-2hours at room temperature, then measure.<br>+25°C to +65°C<br>80%RH to 98%RH<br>Apply the 24h treatment shown below, 10 consecutive times.<br><br>Post-treatment |
| 7  | Biased Humidity     | Appearance<br>Capacitance Change<br>Q or D.F.<br>I.R.(Room Temp.) | No defects or abnormalities.<br>Within +/-12.5%<br>$DF \leq 0.035$<br>More than $50\Omega \cdot F$ | Mounting method<br>Pre-treatment<br>Test Temperature<br>Test Humidity<br>Test Time<br>Test Voltage<br>Charge/discharge current<br>Post-treatment | Mount the capacitor on the test substrate using a conductive glue*.<br>*Conductive glue:HEREAUS"PC3000", Curing conditions:140°C/30min<br>Heat treatment:Perform a heat treatment at 150+0/-10°C for 1 hour and then let sit for 24+/-2hours at room temperature, then measure.<br>85+/-3°C<br>80%RH to 85%RH<br>1000+/-12h<br>The rated voltage and 1.3+0.2/-0Vdc (add 6.8kΩ resistor)<br>50mA max.<br>Non treatment:Let sit for 24+/-2hours at room temperature, then measure.           |
| 8  | Operational Life    | Appearance<br>Capacitance Change<br>Q or D.F.<br>I.R.(Room Temp.) | No defects or abnormalities.<br>Within +/-12.5%<br>$DF \leq 0.035$<br>More than $50\Omega \cdot F$ | Mounting method<br>Pre-treatment<br>Test Temperature<br>Test Time<br>Test Voltage<br>Charge/discharge current<br>Post-treatment                  | Mount the capacitor on the test substrate using a conductive glue*.<br>*Conductive glue:HEREAUS"PC3000", Curing conditions:140°C/30min<br>Voltage treatment:Apply the test voltage at the test temperature for 1 hour and then let sit for 24+/-2hours at room temperature, then measure.<br>Maximum Operating Temperature +/-3°C<br>1000+/-12h<br>75% of the rated voltage<br>50mA max.<br>Non treatment:Let sit for 24+/-2hours at room temperature, then measure.                       |

■ Specifications and Test Methods

| No | Item  | Specification   |  | Test Method (Compliant Standard:AEC-Q200)   |   |
|----|---|---|--|---|---|
| 9  | Operational Life 2<br>(Voltage derated product) | Appearance<br>Capacitance Change<br>Q or D.F.<br>I.R.(Room Temp.) | No defects or abnormalities.<br>Within +/-12.5%<br>DF ≤ 0.035<br>More than 50Ω · F   | Mounting method<br>Pre-treatment<br>Test Temperature<br>Test Time<br>Test Voltage<br>Charge/discharge current<br>Post-treatment | Mount the capacitor on the test substrate using a conductive glue*.<br>*Conductive glue:HEREAUS"PC3000", Curing conditions:140°C/30min<br>Voltage treatment:Apply the test voltage at the Maximum Operating Temperature +/-3°C for 1hour and then let sit for 24+/-2hours at room temperature, then measure.<br>125+/-3°C<br>1000+/-12h<br>150% of the rated voltage<br>50mA max.<br>Non treatment:Let sit for 24+/-2hours at room temperature, then measure. |
| 10 | Appearance                                      | No defects or abnormalities.                                      |  | Visual inspection   |   |
| 11 | Dimension                                       | Shown in Dimension.   |  | Using Measuring instrument of dimension.  |   |
| 12 | Resistance to Solvents                          | Appearance<br>Capacitance<br>Q or D.F.<br>I.R.(Room Temp.)        | No defects or abnormalities.<br>Within the specified initial value.<br>Within the specified initial value.<br>More than 500Ω · F | Per MIL-STD-202 Method 215  |   |
| 13 | Mechanical Shock                                | Appearance<br>Capacitance<br>Q or D.F.<br>I.R.(Room Temp.)        | No defects or abnormalities.<br>Within the specified initial value.<br>Within the specified initial value.<br>More than 500Ω · F | Mounting method<br>Waveform<br>Peak value<br>Holding Time<br>Velocity change<br>Shocks directions and times                     | Mount the capacitor on the test substrate using a conductive glue*.<br>*Conductive glue:HEREAUS"PC3000", Curing conditions:140°C/30min<br>Half-sine<br>1500g<br>0.5ms<br>4.7m/s<br>Three shocks in each direction should be applied along 3 mutually perpendicular axes of the test specimen (18 shocks).   |
| 14 | Vibration                                       | Appearance<br>Capacitance<br>Q or D.F.<br>I.R.(Room Temp.)        | No defects or abnormalities.<br>Within the specified initial value.<br>Within the specified initial value.<br>More than 500Ω · F | Mounting method<br>Kind of Vibration<br>Vibration Time<br>Total amplitude<br>Vibration directions and time                      | Mount the capacitor on the test substrate using a conductive glue*.<br>*Conductive glue:HEREAUS"PC3000", Curing conditions:140°C/30min<br>A 10Hz to 2000Hz to 10Hz<br>20min<br>1.5mm<br>This motion should be applied for 12 times in each 3 mutually perpendicular directions (total of 36 times).   |
| 15 | ESD   | Appearance<br>Capacitance<br>Q or D.F.<br>I.R.(Room Temp.)        | No defects or abnormalities.<br>Within the specified initial value.<br>Within the specified initial value.<br>More than 500Ω · F | Per AEC-Q200-002<br>Post-treatment  | Heat treatment:Perform a heat treatment at 150+0/-10°C for 1hour and then let sit for 24+/-2hours at room temperature, then measure.  |
| 16 | Capacitance                                     | Shown in Rated value.   |  | Measurement Temperature<br>Measurement Frequency<br>Measurement Voltage   | 25°C<br>1.0+/-0.1kHz<br>1.0+/-0.2Vrms   |
| 17 | Q or Dissipation Factor (D.F.)                  | DF ≤ 0.025  |  | Measurement Temperature<br>Measurement Frequency<br>Measurement Voltage   | 25°C<br>1.0+/-0.1kHz<br>1.0+/-0.2Vrms   |

■ Specifications and Test Methods

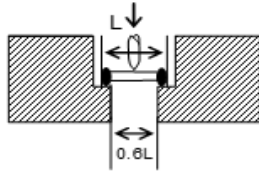
| No   | Item  | Specification  | Test Method (Compliant Standard:AEC-Q200)  |      |                 |   |                      |   |                           |     |                      |   |                           |   |                      |
|------|---|--|--|------|-----------------|---|----------------------|---|---------------------------|-----|----------------------|---|---------------------------|---|----------------------|
| 18   | Insulation Resistance(I.R.) (Room Temperature)  | More than 500Ω · F   | Measurement Temperature 25°C<br>Measurement Voltage Rated Voltage<br>Charging Time 2min<br>Charge/discharge current 50mA max.  |      |                 |   |                      |   |                           |     |                      |   |                           |   |                      |
| 19   | Insulation Resistance(I.R.) (High Temperature)  | More than 1Ω · F   | Measurement Temperature 150°C<br>Measurement Voltage 50% of the rated voltage<br>Charging Time 2min<br>Charge/discharge current 50mA max.  |      |                 |   |                      |   |                           |     |                      |   |                           |   |                      |
| 20   | Insulation Resistance(I.R.) (High Temperature2) | More than 10Ω · F  | Measurement Temperature 125°C<br>Measurement Voltage Rated Voltage<br>Charging Time 2min<br>Charge/discharge current 50mA max.   |      |                 |   |                      |   |                           |     |                      |   |                           |   |                      |
| 21   | Voltage proof                                   | No defects or abnormalities.   | Test Voltage 250% of the rated voltage<br>Applied Time 1s to 5s<br>Charge/discharge current 50mA max.  |      |                 |   |                      |   |                           |     |                      |   |                           |   |                      |
| 22   | Terminal Strength                               | Appearance No defects or abnormalities.<br>Capacitance Within the specified initial value.<br>Q or D.F. Within the specified initial value.<br>I.R.(Room Temp.) More than 500Ω · F | Mounting method Mount the capacitor on the test substrate using a conductive glue*.<br>*Conductive glue:HEREAUS"PC3000", Curing conditions:140°C/30min<br>Applied Force 12.6N<br>Holding Time 60s  |      |                 |   |                      |   |                           |     |                      |   |                           |   |                      |
| 23   | Beam Load Test                                  | Destruction Value: More than 54.5N   | Speed supplied the Stress Load 0.5mm/s<br>Placement diagram<br><br><div style="text-align: center;"> <p>&lt; Chip Length : 3.2mm min. &gt;</p>  </div>   |      |                 |   |                      |   |                           |     |                      |   |                           |   |                      |
| 24   | Temperature Characteristics of Capacitance      | No bias Shown in Rated value.  | The capacitance change should be measured after 5 min at each specified temp. stage.<br>Capacitance value as a reference is the value in "*" marked step.<br>Measurement Voltage Less than 1.0Vrms (Refer to the individual data sheet)<br>Pre-treatment Heat treatment:Perform a heat treatment at 150+0/-10°C for 1hour and then let sit for 24+/-2hours at room temperature, then measure.<br>Temperature Step<br><div style="text-align: center;"> <p>&lt; No bias &gt;</p> <table border="1"> <thead> <tr> <th>Step</th> <th>Temperature(°C)</th> </tr> </thead> <tbody> <tr> <td>1</td> <td>Reference Temp. +/-2</td> </tr> <tr> <td>2</td> <td>Min. Operating Temp. +/-3</td> </tr> <tr> <td>3 *</td> <td>Reference Temp. +/-2</td> </tr> <tr> <td>4</td> <td>Max. Operating Temp. +/-3</td> </tr> <tr> <td>5</td> <td>Reference Temp. +/-2</td> </tr> </tbody> </table> </div> | Step | Temperature(°C) | 1 | Reference Temp. +/-2 | 2 | Min. Operating Temp. +/-3 | 3 * | Reference Temp. +/-2 | 4 | Max. Operating Temp. +/-3 | 5 | Reference Temp. +/-2 |
| Step | Temperature(°C)                                 |  |  |      |                 |   |                      |   |                           |     |                      |   |                           |   |                      |
| 1    | Reference Temp. +/-2                            |  |  |      |                 |   |                      |   |                           |     |                      |   |                           |   |                      |
| 2    | Min. Operating Temp. +/-3                       |  |  |      |                 |   |                      |   |                           |     |                      |   |                           |   |                      |
| 3 *  | Reference Temp. +/-2                            |  |  |      |                 |   |                      |   |                           |     |                      |   |                           |   |                      |
| 4    | Max. Operating Temp. +/-3                       |  |  |      |                 |   |                      |   |                           |     |                      |   |                           |   |                      |
| 5    | Reference Temp. +/-2                            |  |  |      |                 |   |                      |   |                           |     |                      |   |                           |   |                      |

**Mounting method**

- Test substrate  
Material Alumina Substrate
- Land Dimension

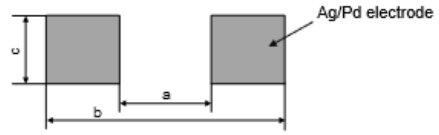

Fig.1

| Type  | Dimension(mm) |     |     |
|-------|---------------|-----|-----|
|       | a             | b   | c   |
| GCG32 | 2.2           | 5.0 | 2.9 |

■ Package (Tape Carrier Packaging)

1. Minimum Quantity(pcs./reel)

| Type  |   | φ180mm Reel(W8P4) | φ330mm Reel(W8P4) |
|-------|---|-------------------|-------------------|
|       |   | Plastic Tape      | Plastic Tape      |
|       |   | CODE : L          | CODE : K          |
| GCG32 | E | 1000              | 4000              |

2. Dimensions of Tape (in mm)

(1)GCG32(W8P4 CODE : K/L)



| Type  |   | Dimensions(Chip) |           |           | A           | B           | C         | D          | E          | F         | G         | H         | J           | K        | L         |
|-------|---|------------------|-----------|-----------|-------------|-------------|-----------|------------|------------|-----------|-----------|-----------|-------------|----------|-----------|
|       |   | L                | W         | T         |             |             |           |            |            |           |           |           |             |          |           |
| GCG32 | E | 3.2+/-0.4        | 2.5+/-0.3 | 2.5+/-0.3 | 2.80+/-0.20 | 3.50+/-0.20 | 8.0+/-0.3 | 3.5+/-0.05 | 1.75+/-0.1 | 4.0+/-0.1 | 2.0+/-0.1 | 4.0+/-0.1 | φ1.5+0.1/-0 | 3.7 max. | 0.3+/-0.1 |

■ Package (Tape Carrier Packaging)

3. Dimensions of Reel (in mm)



| Reel               | A                 | B              | C               | D               | E           | W         | W1        |
|--------------------|-------------------|----------------|-----------------|-----------------|-------------|-----------|-----------|
| $\phi 180$ mm Reel | $\phi 180+0/-3.0$ | $\phi 50$ min. | $\phi 13+/-0.2$ | $\phi 21+/-0.8$ | $2.0+/-0.5$ | 14.4 max. | $8.4+1.5$ |
| $\phi 330$ mm Reel | $\phi 330+/-2.0$  | $\phi 50$ min. | $\phi 13+/-0.2$ | $\phi 21+/-0.8$ | $2.0+/-0.5$ | 14.4 max. | $8.4+1.5$ |

■ Package (Tape Carrier Packaging)

- Part of the leader and part of the vacant section are attached as follows.  
The sprocket holes are to the right as the tape is pulled toward the user.



- Accumulate tolerance of sprocket holes pitch = +/-0.3mm/10 pitch
- Chip in the tape is enclosed by top tape and bottom tape as shown in 2.Dimensions of Tape.
- The top tape and carrier tape are not attached at the end of the tape for a minimum of 5 pitches.
- There are no jointing for top tape and bottom tape.
- There are no fuzz in the cavity.
- Break down force of top tape : 5N min.  
Break down force of bottom tape : 5N min. (Only a bottom tape existence )
- Reel is made by resin and appeaser and dimension is shown in 3.Dimensions of Reel.  
There are possibly to change the material and dimension due to some impairment.
- Peeling off force : 0.1N to 0.7N in the direction as shown below.

Speed of Peeling off : 300 mm / min



- Label that show the customer parts number, our parts number, our company name, inspection number and quantity, will be put in outside of reel.

**Caution****■ Limitation of Applications**

The products listed in the Specification (hereinafter the product(s) is called as the "Product(s)") are designed and manufactured for applications specified in the Specification. (hereinafter called as the "Specific Application"). We shall not warrant anything in connection with the Products including fitness, performance, adequateness, safety, or quality, in the case of applications listed in from (1) to (11) written at the end of this precautions, which may generally require high performance, function, quality, management of production or safety. Therefore, the Product shall be applied in compliance with the specific application.

WE DISCLAIM ANY LOSS AND DAMAGES ARISING FROM OR IN CONNECTION WITH THE PRODUCTS INCLUDING BUT NOT LIMITED TO THE CASE SUCH LOSS AND DAMAGES CAUSED BY THE UNEXPECTED ACCIDENT, IN EVENT THAT (i) THE PRODUCT IS APPLIED FOR THE PURPOSE WHICH IS NOT SPECIFIED AS THE SPECIFIC APPLICATION FOR THE PRODUCT, AND/OR (ii) THE PRODUCT IS APPLIED FOR ANY FOLLOWING APPLICATION PURPOSES FROM (1) TO (11) (EXCEPT THAT SUCH APPLICATION PURPOSE IS UNAMBIGUOUSLY SPECIFIED AS SPECIFIC APPLICATION FOR THE PRODUCT IN THE SPECIFICATION\*).

(1)Aircraft equipment (2)Aerospace equipment (3)Undersea equipment (4)Power plant control equipment (5)Medical equipment (6)Transportation equipment (7)Traffic control equipment (8)Disaster prevention/security equipment (9)Industrial data-processing equipment (10)Combustion/explosion control equipment (11)Equipment with complexity and/or required reliability equivalent to the applications listed in the above.

For exploring information of the Products which will be compatible with the particular purpose other than those specified in the Specification, please contact our sales offices, distribution agents, or trading companies with which you make a deal, or via our web contact form. Contact form: <https://www.murata.com/contactform>

\*We may design and manufacture particular Products for applications listed in (1) to (11). Provided that, in such case we shall unambiguously specify such Specific Application in the Specification without any exception. Therefore, any other documents and/or performances, whether exist or non-exist, shall not be deemed as the evidence to imply that we accept the applications listed in (1) to (11).

**■ Storage and Operation condition**

1. If store the chip multilayer ceramic capacitors (henceforth just "capacitors") in an atmosphere consisting of high temperature or humidity, sulfur or chlorine gases, contaminants attach to the surface of external electrode, and bondability with conductive glue may deteriorate. Do not store the capacitors in an atmosphere consisting of corrosive gas (e.g., hydrogen sulfide, sulfur dioxide, chlorine, ammonia gas, etc.).  
Storage environment must be at room temperature of +5°C to +40°C and a relative humidity of 20% to 70%, and use the product within six months after receipt.  
In case of packaging, do not open the last wrap, polyethylene bag, till just before using. After unpacking, immediately reseal, or store in a desiccator containing a desiccant.
2. Due to moisture condensation caused by rapid humidity changes, or the photochemical change caused by direct sunlight on the terminal electrodes, the bondability with conductive glue and electrical performance may deteriorate. Do not store capacitors under direct sunlight or in high humidity conditions.
3. This product is limited to conductive glue mounting. Do not apply mounting method other than conductive glue.  
Flow or reflow soldering can result in a lack of adhesive strength on the outer electrode by poor wettability, which may result in chips breaking loose from the PCB.

■ Rating

**1. Temperature Dependent Characteristics**

1. The electrical characteristics of the capacitor can change with temperature.

1-1. For capacitors having larger temperature dependency, the capacitance may change with temperature changes. The following actions are recommended in order to ensure suitable capacitance values.

- (1) Select a suitable capacitance for the operating temperature range.
- (2) The capacitance may change within the rated temperature. When you use a high dielectric constant type capacitor in a circuit that needs a tight (narrow) capacitance tolerance (e.g., a time-constant circuit), please carefully consider the temperature characteristics, and carefully confirm the various characteristics in actual use conditions and the actual system.



**2. Measurement of Capacitance**

1. Measure capacitance with the voltage and frequency specified in the product specifications.

- 1-1. The output voltage of the measuring equipment may decrease occasionally when capacitance is high. Please confirm whether a prescribed measured voltage is impressed to the capacitor.
- 1-2. The capacitance values of high dielectric constant type capacitors change depending on the AC voltage applied. Please consider the AC voltage characteristics when selecting a capacitor to be used in a AC circuit.

**3. Applied Voltage**

1. Do not apply a voltage to the capacitor that exceeds the rated voltage as called out in the specifications.

- 1-1. Applied voltage between the terminals of a capacitor shall be less than or equal to the rated voltage.
  - (1) When AC voltage is superimposed on DC voltage, the zero-to-peak voltage shall not exceed the rated DC voltage. When AC voltage or pulse voltage is applied, the peak-to-peak voltage shall not exceed the rated DC voltage.
  - (2) Abnormal voltages (surge voltage, static electricity, pulse voltage, etc.) shall not exceed the rated DC voltage.

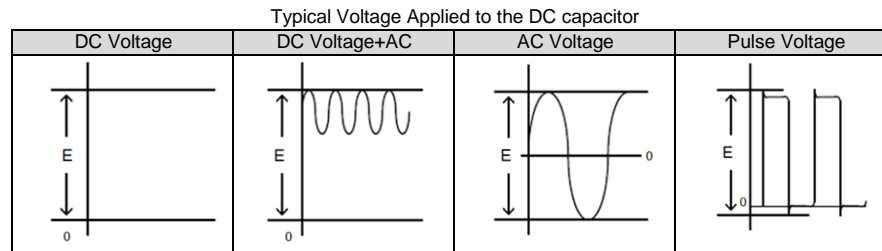

(E : Maximum possible applied voltage.)

1-2. Influence of over voltage

Over voltage that is applied to the capacitor may result in an electrical short circuit caused by the breakdown of the internal dielectric layers. The time duration until breakdown depends on the applied voltage and the ambient temperature.

**4. Type of Applied Voltage and Self-heating Temperature**

1. Confirm the operating conditions to make sure that no large current is flowing into the capacitor due to the continuous application of an AC voltage or pulse voltage. When a DC rated voltage product is used in an AC voltage circuit or a pulse voltage circuit, the AC current or pulse current will flow into the capacitor; therefore check the self-heating condition. Please confirm the surface temperature of the capacitor so that the temperature remains within the upper limits of the operating temperature, including the rise in temperature due to self-heating. When the capacitor is used with a high-frequency voltage or pulse voltage, heat may be generated by dielectric loss.

< Applicable to Rated Voltage of less than 100VDC >

The load should be contained so that the self-heating of the capacitor body remains below 20°C, when measuring at an ambient temperature of 25°C.

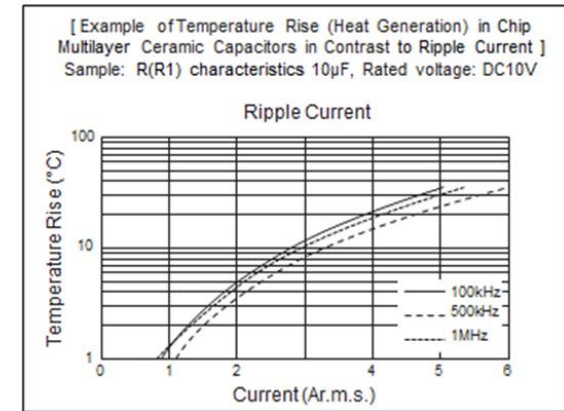

**5. DC Voltage and AC Voltage Characteristic**

1. The capacitance value of a high dielectric constant type capacitor changes depending on the DC voltage applied. Please consider the DC voltage characteristics when a capacitor is selected for use in a DC circuit.

1-1. The capacitance of ceramic capacitors may change sharply depending on the applied voltage. (See figure)  
 Please confirm the following in order to secure the capacitance.

- (1) Determine whether the capacitance change caused by the applied voltage is within the allowed range.
- (2) In the DC voltage characteristics, the rate of capacitance change becomes larger as voltage increases, even if the applied voltage is below the rated voltage. When a high dielectric constant type capacitor is used in a circuit that requires a tight (narrow) capacitance tolerance (e.g., a time constant circuit), please carefully consider the voltage characteristics, and confirm the various characteristics in the actual operating conditions of the system.

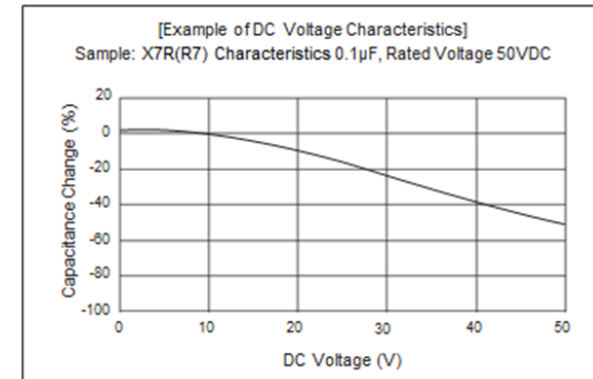

2. The capacitance values of high dielectric constant type capacitors changes depending on the AC voltage applied. Please consider the AC voltage characteristics when selecting a capacitor to be used in a AC circuit.

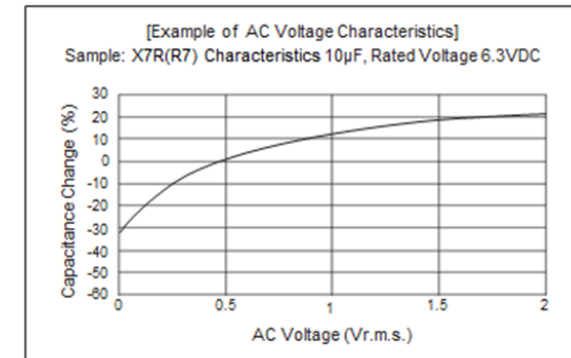

**6. Capacitance Aging**

1. The high dielectric constant type capacitors have an Aging characteristic in which the capacitance value decreases with the passage of time. When you use a high dielectric constant type capacitors in a circuit that needs a tight (narrow) capacitance tolerance (e.g., a time-constant circuit), please carefully consider the characteristics of these capacitors, such as their aging, voltage, and temperature characteristics. In addition, check capacitors using your actual appliances at the intended environment and operating conditions.

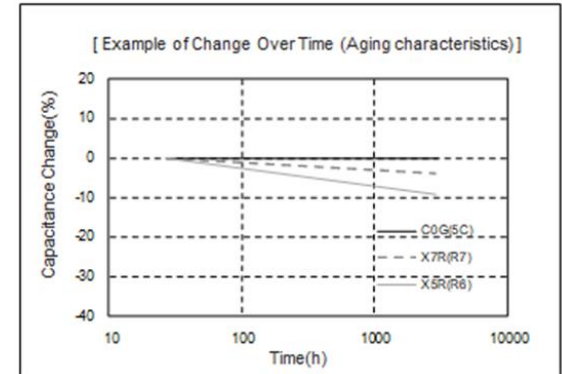

**7. Vibration and Shock**

1. Please confirm the kind of vibration and/or shock, its condition, and any generation of resonance. Please mount the capacitor so as not to generate resonance, and do not allow any impact on the terminals.
2. Mechanical shock due to being dropped may cause damage or a crack in the dielectric material of the capacitor. Do not use a dropped capacitor because the quality and reliability may be deteriorated.
3. When printed circuit boards are piled up or handled, the corner of another printed circuit board should not be allowed to hit the capacitor in order to avoid a crack or other damage to the capacitor.

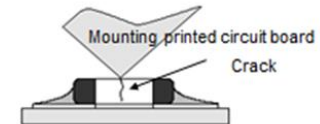
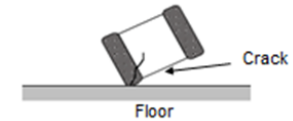

■ **Mounting**

**1. Selection of Conductive Adhesive, Mounting Process, and Bonding Strength**

1. The acquired bonding strength may change greatly depending on the conductive adhesive to be used.  
Be sure to confirming the desired performance can be acquired in the assumed mounting process with the conductive adhesive to be used.

**2. Maintenance of the Mounting (pick and place) Machine**

1. Make sure that the following excessive forces are not applied to the capacitors. Check the mounting in the actual device under actual use conditions ahead of time.
  - 1-1. In mounting the capacitors on the printed circuit board, any bending force against them shall be kept to a minimum to prevent them from any damage or cracking.  
Please take into account the following precautions and recommendations for use in your process.
    - (1) Adjust the lowest position of the pickup nozzle so as not to bend the printed circuit board.

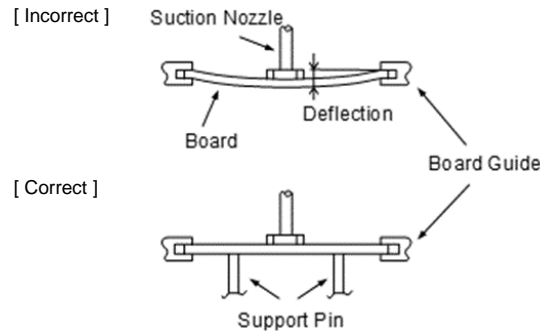

2. Dirt particles and dust accumulated in the suction nozzle and suction mechanism prevent the nozzle from moving smoothly. This creates excessive force on the capacitor during mounting, causing cracked chips.  
Also, the locating claw, when worn out, imposes uneven forces on the chip when positioning, causing cracked chips. The suction nozzle and the locating claw must be maintained, checked and replaced periodically.

**3. Moisture proof**

1. To prevent the silver electrode migration, keep parts under low moisture condition with resin coating and the equivalent.

**4. Coating**

1. A crack may be caused in the capacitor due to the stress of the thermal contraction of the resin during curing process.  
The stress is affected by the amount of resin and curing contraction. Select a resin with low curing contraction.  
The difference in the thermal expansion coefficient between a coating resin or a molding resin and the capacitor may cause the destruction and deterioration of the capacitor such as a crack or peeling, and lead to the deterioration of insulation resistance or dielectric breakdown.  
Select a resin for which the thermal expansion coefficient is as close to that of the capacitor as possible. A silicone resin can be used as an under-coating to buffer against the stress.
2. Select a resin that is less hygroscopic.  
Using hygroscopic resins under high humidity conditions may cause the deterioration of the insulation resistance of a capacitor. An epoxy resin can be used as a less hygroscopic resin.
3. The halogen system substance and organic acid are included in coating material, and a chip corrodes by the kind of Coating material. Do not use strong acid type.

**■ Others****1. Under Operation of Equipment**

- 1-1. Do not touch a capacitor directly with bare hands during operation in order to avoid the danger of an electric shock.
- 1-2. Do not allow the terminals of a capacitor to come in contact with any conductive objects (short-circuit).  
Do not expose a capacitor to a conductive liquid, inducing any acid or alkali solutions.
- 1-3. Confirm the environment in which the equipment will operate is under the specified conditions.  
Do not use the equipment under the following environments.
- (1) Being spattered with water or oil.
  - (2) Being exposed to direct sunlight.
  - (3) Being exposed to ozone, ultraviolet rays, or radiation.
  - (4) Being exposed to toxic gas (e.g., hydrogen sulfide, sulfur dioxide, chlorine, ammonia gas etc.)
  - (5) Any vibrations or mechanical shocks exceeding the specified limits.
  - (6) Moisture condensing environments.
- 1-4. Use damp proof countermeasures if using under any conditions that can cause condensation.

**2. Others**

- 2-1. In an Emergency
- (1) If the equipment should generate smoke, fire, or smell, immediately turn off or unplug the equipment. If the equipment is not turned off or unplugged, the hazards may be worsened by supplying continuous power.
  - (2) In this type of situation, do not allow face and hands to come in contact with the capacitor or burns may be caused by the capacitor's high temperature.
- 2-2. Disposal of waste  
When capacitors are disposed of, they must be burned or buried by an industrial waste vendor with the appropriate licenses.
- 2-3. Circuit Design
- (1) Addition of Fail Safe Function  
Capacitors that are cracked by dropping or bending of the board may cause deterioration of the insulation resistance, and result in a short.  
If the circuit being used may cause an electrical shock, smoke or fire when a capacitor is shorted, be sure to install fail-safe functions, such as a fuse, to prevent secondary accidents.
  - (2) This series are not safety standard certified products.
- 2-4. Remarks  
Failure to follow the cautions may result, worst case, in a short circuit and smoking when the product is used.  
The above notices are for standard applications and conditions. Contact us when the products are used in special mounting conditions.  
Select optimum conditions for operation as they determine the reliability of the product after assembly.  
The data herein are given in typical values, not guaranteed ratings.

## Notice

### ■ Rating

#### 1. Operating Temperature

1. The operating temperature limit depends on the capacitor.
  - 1-1. Do not apply temperatures exceeding the maximum operating temperature.  
It is necessary to select a capacitor with a suitable rated temperature that will cover the operating temperature range.  
It is also necessary to consider the temperature distribution in equipment and the seasonal temperature variable factor.
  - 1-2. Consider the self-heating factor of the capacitor  
The surface temperature of the capacitor shall not exceed the maximum operating temperature including self-heating.

#### 2. Atmosphere Surroundings (gaseous and liquid)

1. Restriction on the operating environment of capacitors.
  - 1-1. The capacitor will short-circuit by water or brine. It may shorten the lifetime and may have the failure by the corrosion of terminals and the permeation of moisture into capacitor.
  - 1-2. The same phenomenon as the above may occur when the electrodes or terminals of the capacitor are subject to moisture condensation.
  - 1-3. The deterioration of characteristics and insulation resistance due to the oxidization or corrosion of terminal electrodes may result in breakdown when the capacitor is exposed to corrosive or volatile gases or solvents for long periods of time.

#### 3. Piezo-electric Phenomenon

1. When using high dielectric constant type capacitors in AC or pulse circuits, the capacitor itself vibrates at specific frequencies and noise may be generated. Moreover, when the mechanical vibration or shock is added to capacitor, noise may occur.

**■ Others****1. Transportation**

1. The performance of a capacitor may be affected by the conditions during transportation.

1-1. The capacitors shall be protected against excessive temperature, humidity and mechanical force during transportation.

· Mechanical condition

Transportation shall be done in such a way that the boxes are not deformed and forces are not directly passed on to the inner packaging.

1-2. Do not apply excessive vibration, shock, or pressure to the capacitor.

(1) When excessive mechanical shock or pressure is applied to a capacitor, chipping or cracking may occur in the ceramic body of the capacitor.

(2) When the sharp edge of an air driver, tweezers, a chassis, etc. impacts strongly on the surface of the capacitor, the capacitor may crack and short-circuit.

1-3. Do not use a capacitor to which excessive shock was applied by dropping etc. A capacitor dropped accidentally during processing may be damaged.

**2. Characteristics Evaluation in the Actual System**

1. Evaluate the capacitor in the actual system, to confirm that there is no problem with the performance and specification values in a finished product before using.

2. Since a voltage dependency and temperature dependency exists in the capacitance of high dielectric type ceramic capacitors, the capacitance may change depending on the operating conditions in the actual system. Therefore, be sure to evaluate the various characteristics, such as the leakage current and noise absorptivity, which will affect the capacitance value of the capacitor.

3. In addition, voltages exceeding the predetermined surge may be applied to the capacitor by the inductance in the actual system. Evaluate the surge resistance in the actual system as required.

**NOTE**

1. Please make sure that your product has been evaluated in view of your specifications with our product being mounted to your product.
2. You are requested not to use our product deviating from this product specification.
3. We consider it not appropriate to include any terms and conditions with regard to the business transaction in the product specifications, drawings or other technical documents.  
Therefore, if your technical documents as above include such terms and conditions such as warranty clause, product liability clause, or intellectual property infringement liability clause, they will be deemed to be invalid.