

Reference Specification

Safety Standard Certified Resin Molding SMD Type Ceramic Capacitors for
Consumer Electronics & Industrial Equipment /Type EA

Product specifications in this catalog are as of Apr. 2026, and are subject to change or
obsolescence without notice.
Please consult the approval sheet before ordering. Please read rating and Cautions first.

XZ091A(Y10)

<Reference> Please kindly use our website.

Please refer to the product information page for more information on ceramic capacitors. → [Ceramic capacitor product information](#)

Various data can be obtained directly from the product search. → [Product search \(SMD\)](#) / [Product search \(Lead Type\)](#)

[CONTENTS]

- **Scope**
- **Rating**
- **Marking**
- **Part number list**
- **Specification**
- **Complement of Test Method**
- **Packing**
- ** CAUTION & NOTICE & NOTE**

1.Scope

This product specification is applied to Safety Standard Certified Resin Molding SMD Type Ceramic Capacitors Type EA.

The safety standard certification is obtained as Class X1, Y1.

1. Specific applications:

- Consumer Equipment: Products that can be used in consumer equipment such as home appliances, audio/visual equipment, communication equipment, information equipment, office equipment, and household robotics, and whose functions are not directly related to the protection of human life and property.
- Industrial Equipment: Products that can be used in industrial equipment such as base stations, manufacturing equipment, industrial robotics equipment, and measurement equipment, and whose functions do not directly relate to the protection of human life and property.
- Medial Equipment [GHTF A/B/C] except for Implant Equipment: Products suitable for use in medical devices designated under the GHTF international classifications as Class A or Class B (the functions of which are not directly involved in protection of human life or property) or in medical devices other than implants designated under the GHTF international classifications as Class C (the malfunctioning of which is considered to pose a comparatively high risk to the human body).
- Automotive infotainment/comfort equipment: Products that can be used for automotive equipment such as car navigation systems and car audio systems that do not directly relate to human life and whose structure, equipment, and performance are not specifically required by law to meet technical standards for safety assurance or environmental protection.

2. Unsuitable Application: Applications listed in "Limitation of applications" in this product specification. WE DISCLAIM ANY LOSS AND DAMAGES ARISING FROM OR IN CONNECTION WITH THE PRODUCTS INCLUDING BUT NOT LIMITED TO THE CASE SUCH LOSS AND DAMAGES CAUSED BY THE UNEXPECTED ACCIDENT, IN EVENT THAT THE PRODUCT IS APPLIED FOR THE PURPOSE WHICH IS SPECIFIED ABOVE AS THE UNSUITABLE APPLICATION FOR THE PRODUCT.

Approval standard and certified number

	Standard number	*Certified number	Rated voltage
UL/cUL	UL60384-14/CSA E60384-14	E37921	X1: AC440 V(r.m.s.) / DC1,500 V Y1: AC300 V(r.m.s.) / DC1,500 V
ENEC (SEMKO)	EN IEC 60384-14	SE-ENEC-2401372R1	X1: AC440 V(r.m.s.) Y1: AC300 V(r.m.s.)
CQC	IEC60384-14	CQC16001142384	

*Above Certified number may be changed on account of the revision of standards and the renewal of certification.

2.Rating

2-1. Operating temperature range

-40 ~ 125 °C

2-2. Rated Voltage

X1: AC440 V(r.m.s.)
Y1: AC300 V(r.m.s.)
DC1,500 V

Reference only

2-3.Part number configuration

ex.)

<u>DK1</u>	<u>F3</u>	<u>EA</u>	<u>222</u>	<u>M</u>	<u>86</u>	<u>R</u>	<u>BH01</u>
Series	Temperature Characteristics	Certified Type	Capacitance	Capacitance Tolerance	Body Dimension	Package	Individual Specification

• Series

DK1 denotes resin molding SMD type safety standard recognized ceramic capacitor of class Y1.

• Temperature Characteristics

Please confirm detailed specification on [Specification and test methods].

Code	Temperature Characteristics
1X	SL
B3	B
E3	E
F3	F

• Certified Type

This denotes safety certified type name Type EA.

• Capacitance

The first two digits denote significant figures ; the last digit denotes the multiplier of 10 in pF.
ex.) In case of 222 .

$$22 \times 10^2 = 2200 \text{ pF}$$

• Capacitance Tolerance

Please refer to [Part number list].

• Body Dimension

Code	Body Dimension
86	8.0 × 6.0 mm

• Package

Code	Package
H	Φ180 mm Reel type
R	Φ330 mm Reel type

• Individual Specification

Murata's control code

Please refer to Part number list .

Reference only

3. Marking

Certified type : EA
Capacitance : Actual value(under 100 pF)
3 digit system(100 pF and over)
Rated Voltage : X1 440~
Y1 300~
Company name code : M15 (Made in Thailand)
Manufacturing year : Letter code (The last digit of A.D. year.)
Manufacturing month : Code

ex.) YEAR MONTH
2022 11(November)
2N*

*From January to September : "1" to "9",
October : "O" , November : "N" , December : "D"

(Example)

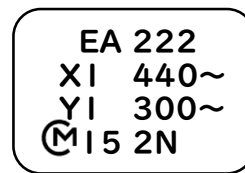

Reference only

4. Part number list

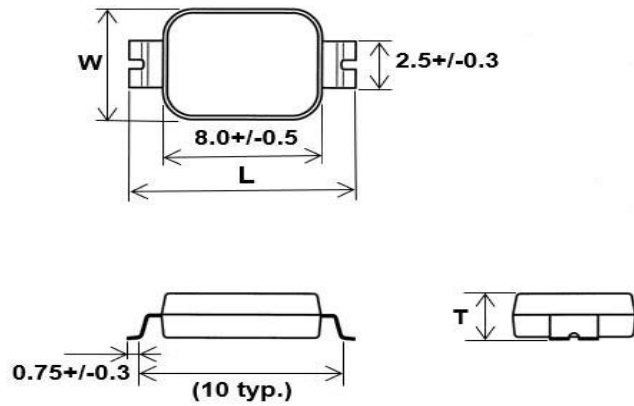

Unit : mm

Customer Part Number	Murata Part Number	T.C.	Cap. (pF)	Cap. tol.	Dimension (mm)			Body Dimension	Pack qty. (pcs)
					L	W	T max.		
	DK11XEA100K86HBH01	SL	10	±10%	11.4±0.5	6.0±0.5	2.5	86	500
	DK11XEA220K86HBH01	SL	22	±10%	11.4±0.5	6.0±0.5	2.5	86	500
	DK11XEA470K86HBH01	SL	47	±10%	11.4±0.5	6.0±0.5	2.5	86	500
	DK1B3EA101K86HBH01	B	100	±10%	11.4±0.5	6.0±0.5	2.5	86	500
	DK1B3EA221K86HBH01	B	220	±10%	11.4±0.5	6.0±0.5	2.5	86	500
	DK1B3EA331K86HBH01	B	330	±10%	11.4±0.5	6.0±0.5	2.5	86	500
	DK1B3EA471K86HBH01	B	470	±10%	11.4±0.5	6.0±0.5	2.5	86	500
	DK1B3EA681K86HBH01	B	680	±10%	11.4±0.5	6.0±0.5	2.5	86	500
	DK1E3EA102M86HBH01	E	1000	±20%	11.4±0.5	6.0±0.5	2.5	86	500
	DK1E3EA152M86HBH01	E	1500	±20%	11.4±0.5	6.0±0.5	2.5	86	500
	DK1F3EA222M86HBH01	F	2200	±20%	11.4±0.5	6.0±0.5	2.5	86	500
	DK11XEA100K86RBH01	SL	10	±10%	11.4±0.5	6.0±0.5	2.5	86	2500
	DK11XEA220K86RBH01	SL	22	±10%	11.4±0.5	6.0±0.5	2.5	86	2500
	DK11XEA470K86RBH01	SL	47	±10%	11.4±0.5	6.0±0.5	2.5	86	2500
	DK1B3EA101K86RBH01	B	100	±10%	11.4±0.5	6.0±0.5	2.5	86	2500
	DK1B3EA221K86RBH01	B	220	±10%	11.4±0.5	6.0±0.5	2.5	86	2500
	DK1B3EA331K86RBH01	B	330	±10%	11.4±0.5	6.0±0.5	2.5	86	2500
	DK1B3EA471K86RBH01	B	470	±10%	11.4±0.5	6.0±0.5	2.5	86	2500
	DK1B3EA681K86RBH01	B	680	±10%	11.4±0.5	6.0±0.5	2.5	86	2500
	DK1E3EA102M86RBH01	E	1000	±20%	11.4±0.5	6.0±0.5	2.5	86	2500
	DK1E3EA152M86RBH01	E	1500	±20%	11.4±0.5	6.0±0.5	2.5	86	2500
	DK1F3EA222M86RBH01	F	2200	±20%	11.4±0.5	6.0±0.5	2.5	86	2500

Reference only

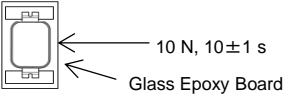
5. Specification																
No.	Test Item		Specification	Test Method (Ref. Standard:JIS C 5101(all parts), IEC60384(all parts))												
1	Operating Temperature		-40 to 125 °C													
2	Appearance		No defects or abnormalities	Visual inspection.												
3	Dimensions		Within the specified dimension.	Using calipers and micrometers.												
4	Dielectric strength	Between Terminals	No defects or abnormalities.	The capacitor shall not be damage when AC4,000 V(r.m.s.) and DC6,000 V is applied between the terminations for 60 s.												
		Terminal To External Resin	No defects or abnormalities.	The capacitor shall not be damage when AC4,000 V(r.m.s.) and DC6,000 V is applied between the terminations for 60 s.												
5	Insulation Resistance (I.R.)		6,000 MΩ or more.	The insulation resistance shall be measured with DC500±50 V within 60 ±5 s of charging. The voltage should be applied to the capacitor through a resistor of 1 M Ω.												
6	Capacitance		Within the specified tolerance.	Capacitance/D.F. shall be measured at 20 °C with the frequency of 1±0.2 kHz and a voltage of AC1±0.2 V(r.m.s.).												
7	Dissipation Factor (D.F.)		SL,B,E : DF ≤ 0.025 F : DF ≤ 0.05													
8	Capacitance Temperature characteristic		Temp. Coefficient SL: +350 to -1000 ppm/°C (Temp. Range: 20 to 85°C) Cap. Change B:within ±10 % E:within +20/-55 % F:within +30/-80 % (Temp. Range:-25 to 85 °C)	The capacitance measurement shall be made at each step in table. •Pre-treatment for B, E, F char. Perform the heat treatment at 150+0/-10 °C for 60±5 min and then let sit for 24±2 h at *room condition.												
				<table border="1"> <thead> <tr> <th>Step</th> <th>1</th> <th>2</th> <th>3</th> <th>4</th> <th>5</th> </tr> </thead> <tbody> <tr> <td>Temp.(°C)</td> <td>20±2</td> <td>-25±2</td> <td>20±2</td> <td>85±2</td> <td>20±2</td> </tr> </tbody> </table>	Step	1	2	3	4	5	Temp.(°C)	20±2	-25±2	20±2	85±2	20±2
Step	1	2	3	4	5											
Temp.(°C)	20±2	-25±2	20±2	85±2	20±2											
9	Vibration resistance	Appearance	No marked defect.	Solder the capacitor to the Test Jig A (glass epoxy board) shown in "Complement of test method". The capacitor shall be subjected to a simple harmonic motion having a total amplitude of 1.5mm, the frequency being varied uniformly between the approximate limits of 10 and 55 Hz. The frequency range, from 10 to 55 Hz and return to 10Hz, shall be traversed in approximately 1 min. This motion shall be applied for a period of 2 h in each of 3 mutually perpendicular directions (total of 6 h).												
		Capacitance	Within the specified tolerance.													
		Dissipation Factor (D.F.)	Pass the item No.7.													
10	Solderability of termination		75 % of the terminations are to be soldered .	Immerse the capacitor in the solution of rosin ethanol (25% rosin in weight proportion). Immerse in solder solution for 2±0.5 s. Temp. of solder : 245±5 °C												
11	Soldering effect (Reflow)	Appearance	No marked defects.	Preheat the capacitor at 150 to 180 °C for 90±30 s. Reflow temp. : 230 °C min. (Max. temp. : 260 °C) Reflow time : 30±10 s. Reflow number of times : 4 times The next reflow process should be done after the temperature of the sample has dropped to room temperature. • Pre-treatment for B, E, F char. Capacitor should be stored at 150+0/-10 °C for 1 h, and apply the AC4,000 V(r.m.s.) 60 s then placed at *room condition for 24±2 h before initial measurements. • Post-treatment Let sit at *room condition for 24±2 h, then measure.												
		Capacitance change	Within ±10 %													
		I.R.	1,000 MΩ or more.													
		Dielectric strength	Pass the item No.4.													
12	Adhesive strength of termination		No removal of the terminations or other defects should occur.	Solder the capacitor to the Test Jig A (glass epoxy board) shown in "Complement of Test method". Then apply 10 N force in the direction of the arrow. 												

*"room condition" Temperature : 15 to 35 °C, Relative humidity : 45 to 75 %, Atmospheric pressure : 86 to 106 kPa

Reference only

No.	Test Item	Specification	Test Method (Ref. Standard:JIS C 5101(all parts), IEC60384(all parts))															
13	Temperature cycle	Appearance	No marked defect.															
		Capacitance change	Within $\pm 15\%$															
		Dissipation Factor (D.F.)	SL : $DF \leq 0.025$ B,E : $DF \leq 0.05$ F : $DF \leq 0.075$															
		I.R.	3,000 M Ω or more															
		Dielectric strength	Pass the item No.4.															
			<p>Fix the capacitor to the supporting Test Jig A (glass epoxy board) shown in "Complement of test method".</p> <p>Perform the 5 cycles according to the 4 heat treatments listed the following table.</p> <table border="1" data-bbox="943 360 1305 508"> <thead> <tr> <th>Step</th> <th>Temp.(°C)</th> <th>Time(min.)</th> </tr> </thead> <tbody> <tr> <td>1</td> <td>-40\pm3</td> <td>30\pm3</td> </tr> <tr> <td>2</td> <td>Room Temp.</td> <td>2 to 3</td> </tr> <tr> <td>3</td> <td>125\pm3</td> <td>30\pm3</td> </tr> <tr> <td>4</td> <td>Room Temp.</td> <td>2 to 3</td> </tr> </tbody> </table> <p>• Pre-treatment for B, E, F char. Capacitor should be stored at 150+0/-10 °C for 1 h, and apply the AC4,000 V(r.m.s.) 60 s then placed at *room condition for 24\pm2 h before initial measurements.</p> <p>• Post-treatment Let sit at *room condition for 24\pm2 h, then measure.</p>	Step	Temp.(°C)	Time(min.)	1	-40 \pm 3	30 \pm 3	2	Room Temp.	2 to 3	3	125 \pm 3	30 \pm 3	4	Room Temp.	2 to 3
Step	Temp.(°C)	Time(min.)																
1	-40 \pm 3	30 \pm 3																
2	Room Temp.	2 to 3																
3	125 \pm 3	30 \pm 3																
4	Room Temp.	2 to 3																
14	Humidity (Steady state)	Appearance	No marked defect.															
		Capacitance change	Within $\pm 20\%$															
		Dissipation Factor (D.F.)	SL : $DF \leq 0.025$ B,E : $DF \leq 0.05$ F : $DF \leq 0.075$															
		I.R.	3,000 M Ω or more															
		Dielectric strength	Pass the item No.4.															
			<p>Sit the capacitor at 40\pm2 °C and relative humidity 90 to 95 % for 500+24/-0 h.</p> <p>• Pre-treatment for B, E, F char. Capacitor should be stored at 150+0/-10 °C for 1 h, and apply the AC4,000 V(r.m.s.) 60 s then placed at *room condition for 24\pm2 h before initial measurements.</p> <p>• Post-treatment Remove and let sit for 24\pm2 h at *room condition, then measure.</p>															
15-1	Humidity loading (AC)	Appearance	No marked defect.															
		Capacitance change	Within $\pm 20\%$															
		Dissipation Factor (D.F.)	SL : $DF \leq 0.025$ B,E : $DF \leq 0.05$ F : $DF \leq 0.075$															
		I.R.	3,000 M Ω or more															
		Dielectric strength	Pass the item No.4.															
			<p>Apply the rated voltage AC440 V(r.m.s.) at 40\pm2 °C and relative humidity 90 to 95% for 500+24/-0 h.</p> <p>• Pre-treatment for B, E, F char. Capacitor should be stored at 150+0/-10 °C for 1 h, and apply the AC4,000 V(r.m.s.) 60 s then placed at *room condition for 24\pm2 h before initial measurements.</p> <p>• Post-treatment Remove and let sit for 24\pm2 h at *room condition, then measure.</p>															
15-2	Humidity loading (DC)	Appearance	No marked defect.															
		Capacitance change	Within $\pm 20\%$															
		Dissipation Factor (D.F.)	SL : $DF \leq 0.025$ B,E : $DF \leq 0.05$ F : $DF \leq 0.075$															
		I.R.	3,000 M Ω or more															
		Dielectric strength	Pass the item No.4.															
			<p>Apply the rated voltage DC1,500 V at 40\pm2 °C and relative humidity 90 to 95% for 500+24/-0 h.</p> <p>• Pre-treatment for B, E, F char. Capacitor should be stored at 150+0/-10 °C for 1 h, and apply the AC4,000 V(r.m.s.) 60 s then placed at *room condition for 24\pm2 h before initial measurements.</p> <p>• Post-treatment Remove and let sit for 24\pm2 h at *room condition, then measure.</p>															
* "room condition" Temperature : 15 to 35 °C, Relative humidity : 45 to 75 %, Atmospheric pressure : 86 to 106 kPa																		

Reference only

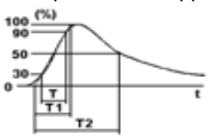
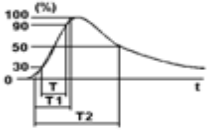
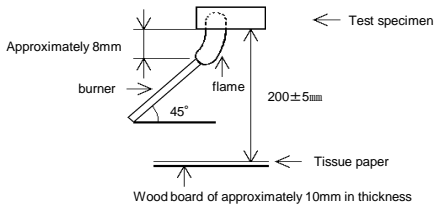
No.	Test Item	Specification	Test Method (Ref. Standard:JIS C 5101(all parts), IEC60384(all parts))		
16-1	Life (AC)				
	Appearance	No marked defect.	Impulse Voltage test is performed. Each individual capacitor shall be subjected to a 8 kV Impulse (the voltage value means zero to peak) for 3 times or more. Then the capacitors are applied to life test.  Front time (T1) = 1.7 μs=1.67T Time to half-value (T2) = 50 μs Apply voltage as Table for 1,000 h at 125+2/-0 °C, relative humidity 50 % max. <table border="1" style="margin-left: auto; margin-right: auto;"> <tr> <th>Applied voltage</th> </tr> <tr> <td>AC550 V(r.m.s.) except that once each hour the voltage is increased to AC1,000 V(r.m.s.) for 0.1 s.</td> </tr> </table> <ul style="list-style-type: none"> • Pre-treatment for B, E, F char. Capacitor should be stored at 150+0/-10 °C for 1 h, and apply the AC4,000 V(r.m.s.) 60 s then placed at *room condition for 24±2 h before initial measurements. • Post-treatment Remove and let sit for 24±2 h at *room condition, then measure. 	Applied voltage	AC550 V(r.m.s.) except that once each hour the voltage is increased to AC1,000 V(r.m.s.) for 0.1 s.
	Applied voltage				
	AC550 V(r.m.s.) except that once each hour the voltage is increased to AC1,000 V(r.m.s.) for 0.1 s.				
Capacitance change	Within ±20 %				
I.R.	3,000 MΩ or more				
16-2	Life (DC)				
	Appearance	No marked defect.	Impulse Voltage test is performed. Each individual capacitor shall be subjected to a 8 kV Impulse (the voltage value means zero to peak) for 3 times or more. Then the capacitors are applied to life test.  Front time (T1) = 1.7 μs=1.67T Time to half-value (T2) = 50 μs Apply DC2,550 V for 1,000 h at 125+2/-0 °C, relative humidity 50 % max. <ul style="list-style-type: none"> • Pre-treatment for B, E, F char. Capacitor should be stored at 150+0/-10 °C for 1 h, and apply the AC4,000 V(r.m.s.) 60 s then placed at *room condition for 24±2 h before initial measurements. • Post-treatment Remove and let sit for 24±2 h at *room condition, then measure. 		
	Capacitance change	Within ±20 %			
	I.R.	3,000 MΩ or more			
17	Passive flammability				
	Appearance	No marked defect.	The burning time should not be exceeded the time 30 s. The tissue paper should not ignite. The capacitor under test shall be held in the flame in the position which best promotes burning. Each specimen shall only be exposed once to the flame. Time of exposure to flame : 30 s. Length of flame : 12±1 mm Gas burner : Length 35 mm min. : Inside dia : 0.5±0.1 mm : Outside dia : 0.9 mm max. Gas : Butane gas purity 95 % min. 		
	Capacitance change	Within ±20 %			
	I.R.	3,000 MΩ or more			
Dielectric strength	Pass the item No.4.				

* "room condition" Temperature : 15 to 35 °C, Relative humidity : 45 to 75 %, Atmospheric pressure : 86 to 106 kPa

Reference only

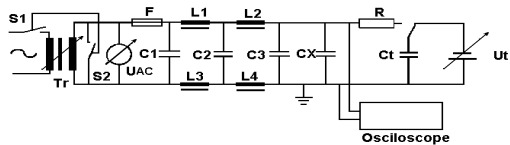
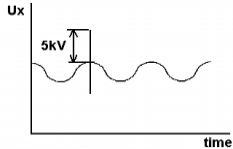
No.	Test Item	Specification	Test Method (Ref. Standard:JIS C 5101(all parts), IEC60384(all parts))
18	Active flammability	The cheese-cloth should not be on fire.	<p>The capacitor shall be individually wrapped in at least one but more than two complete layers of cheesecloth.</p> <p>The capacitor shall be subjected to 20 discharges.</p> <p>The interval between successive discharges shall be 5 s.</p> <p>The UAc shall be maintained for 2 min after the last discharge.</p>  <p>C1,2 : 1 $\mu\text{F} \pm 10\%$, C3 : 0.033 $\mu\text{F} \pm 5\%$ 10 kV L1 to L4 : 1.5 mH $\pm 20\%$ 16A Rod core choke R : 100 $\Omega \pm 2\%$, Ct : 3 $\mu\text{F} \pm 5\%$ 10 kV UAc : UR $\pm 5\%$ UR : Rated voltage F : Fuse, Rated 16 A Cx : Capacitor specimens Ut : Voltage impressed on the tank capacitor Ct</p> 

6. Complement of Test Method

6.1. Test Jig

The test jig should be Jig A as described in "Specifications and Test methods".

The specimen should be soldered by the conditions as described below.

Soldering Method : Reflow soldering

Solder : Sn-3.0Ag-0.5Cu

(1) Test Jig A

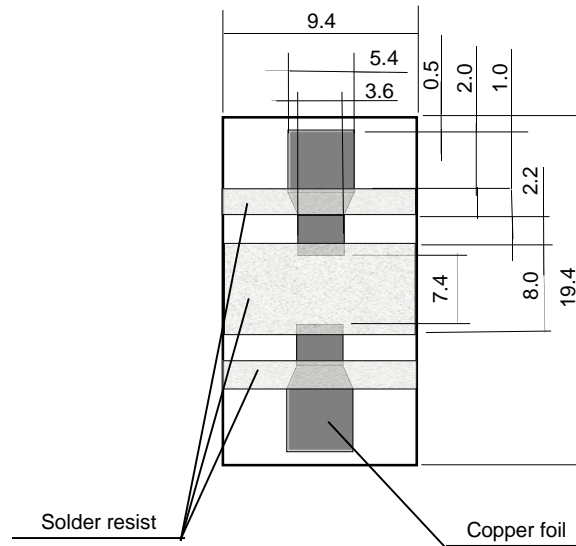

- Material : Glass Epoxy Board
- Thickness : 1.6 mm
- Thickness of copper foil : 0.035 mm

7. Packing

7-1. Dimension of tape

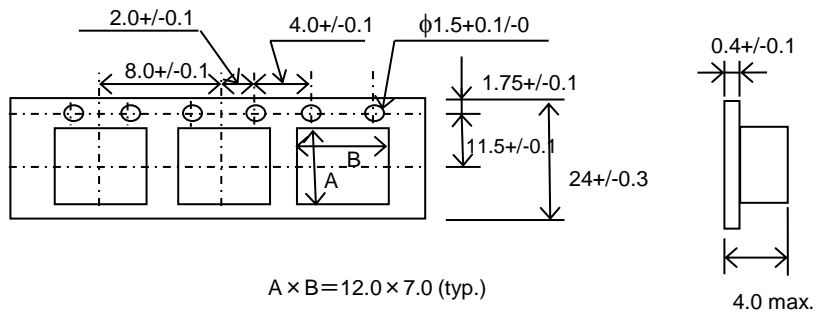

(Unit : mm)

7-2. Dimension of Reel

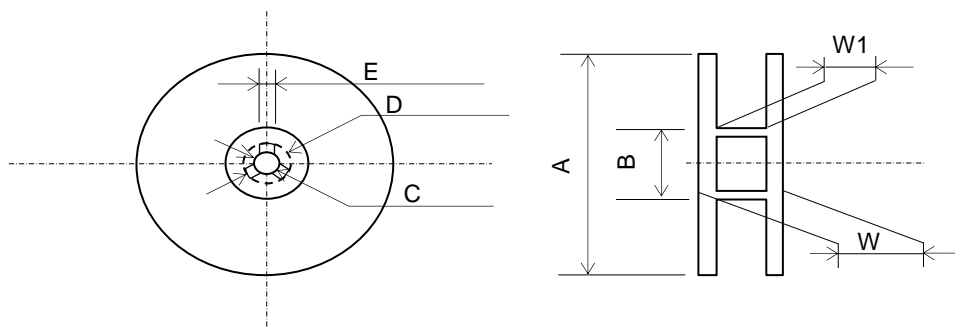

(Unit : mm)

Reel	A	B	C	D	E	W	W1
Φ180mm Reel	180+0/-3.0	60 min.	13.0±0.2	21.0±0.8	2.0±0.5	30.9 max.	26.5 max.
Φ330mm Reel	330±2.0	60 min.	13.0±0.2	21.0±0.8	2.0±0.5	30.4 max.	26.4 max.

(1) Part of the leader and part of the empty tape shall be attached to the end of the tape as follows.

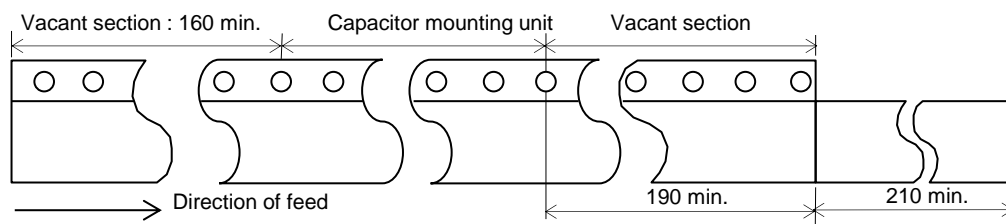

(Unit : mm)

- (2) The top tape or cover tape and base tape are not attached at the end of the tape for a minimum of 2 pitches.
- (3) Missing capacitors number within 0.1 % of the number per reel or 1 pc, whichever is greater, and not continuous.
- (4) The top tape or cover tape and bottom tape shall not protrude beyond the edges of the tape and shall not cover sprocket holes.
- (5) Cumulative tolerance of sprocket holes, 10 pitches : ±0.3 mm.
- (6) Peeling off force : 0.1 to 0.6 N in the direction shown on the follows.

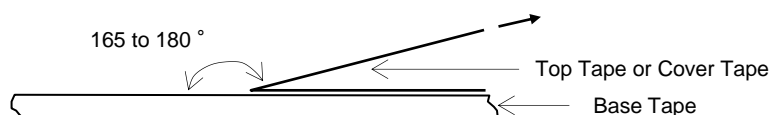

⚠ CAUTION**1. OPERATING VOLTAGE**

- Do not apply a voltage to a safety standard certified product that exceeds the rated voltage as called out in the specifications. Applied voltage between the terminals of a safety standard certified product shall be less than or equal to the rated voltage (+10 %). When a safety standard certified product is used as a DC voltage product, the AC rated voltage value becomes the DC rated voltage value.

(Example: AC250 V (r.m.s.) rated product can be used as DC250 V (+10 %) rated product.)

If both AC rated voltage and DC rated voltage are specified, apply the voltage lower than the respective rated voltage.

- 1-1. When a safety standard certified product is used in a circuit connected to a commercial power supply, ensure that the applied commercial power supply voltage including fluctuation should be less than 10 % above its rated voltage.

- 1-2. When using a safety standard certified product as a DC rated product in circuits other than those connected to a commercial power supply.

When AC voltage is superimposed on DC voltage, the zero-to-peak voltage shall not exceed the rated DC voltage. When AC voltage or pulse voltage is applied, the peak-to-peak voltage shall not exceed the rated DC voltage.

Typical Voltage Applied to the DC Capacitor

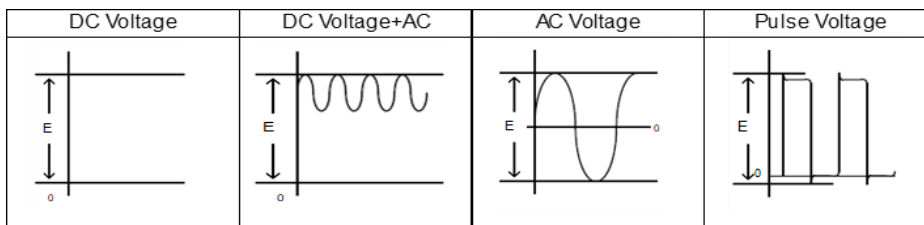

(E: Maximum possible applied voltage.)

- Abnormal voltages (surge voltage, static electricity, pulse voltage, etc.) shall not exceed the rated DC voltage.

2. OPERATING TEMPERATURE AND SELF-GENERATED HEAT

Keep the surface temperature of a capacitor below the upper limit of its rated operating temperature range. Be sure to take into account the heat generated by the capacitor itself.

When the capacitor is used in a high-frequency current, pulse current or the like, it may have the self-generated heat due to dielectric-loss. Applied voltage should be the load such as self-generated heat is within 20 °C on the condition of atmosphere temperature 25 °C. When measuring, use a thermocouple of small thermal capacity-K of $\Phi 0.1$ mm and be in the condition where capacitor is not affected by radiant heat of other components and wind of surroundings. Excessive heat may lead to deterioration of the capacitor's characteristics and reliability. (Never attempt to perform measurement with the cooling fan running. Otherwise, accurate measurement cannot be ensured.)

3. TEST CONDITION FOR WITHSTANDING VOLTAGE**1. TEST EQUIPMENT**

Test equipment for AC withstanding voltage should be used with the performance of the wave similar to 50/60 Hz sine wave.

If the distorted sine wave or over load exceeding the specified voltage value is applied, the defective may be caused.

2. VOLTAGE APPLIED METHOD

When the withstanding voltage is applied, capacitor's lead or terminal should be firmly connected to the out-put of the withstanding voltage test equipment, and then the voltage should be raised from near zero to the test voltage.

If the test voltage without the raise from near zero voltage would be applied directly to capacitor, test voltage should be applied with the *zero cross. At the end of the test time, the test voltage should be reduced to near zero, and then capacitor's lead or terminal should be taken off the out-put of the withstanding voltage test equipment.

If the test voltage without the raise from near zero voltage would be applied directly to capacitor, the surge voltage may arise, and therefore, the defective may be caused.

*ZERO CROSS is the point where voltage sine wave pass 0 V.

- See the right figure -

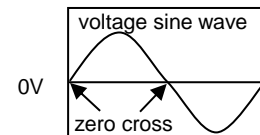

4. FAIL-SAFE

When capacitor would be broken, failure may result in a short circuit. Be sure to provide an appropriate fail-safe function like a fuse on your product if failure would follow an electric shock, fire or fume.

5. VIBRATION AND IMPACT

Do not expose a capacitor or its leads to excessive shock or vibration during use.

6. SOLDERING

When soldering this product to a PCB/PWB, do not exceed the solder heat resistance specification of the capacitor. Subjecting this product to excessive heating could melt the internal junction solder and may result in thermal shocks that can crack the ceramic element.

Please verify that the soldering process does not affect the quality of capacitors.

6-1. Reflow Soldering

Soldering temperature : 230 to 260 °C

Soldering time : 10 to 30 s

Preheating temperature : 170 °C max.

6-2. Flow Soldering

Soldering temperature : 260 °C max.

Soldering time : 5 s max.

Preheating temperature : 120 °C max.

Preheating time : 60 s max.

6-3. Soldering Iron

Temperature of iron-tip : 400 °C max.

Soldering iron wattage : 50 W max.

Soldering time : 3.5 s max.

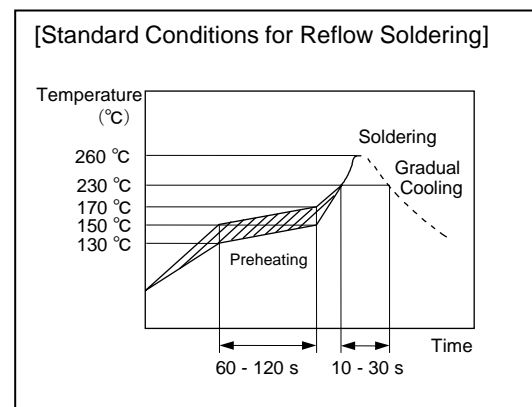

7. BONDING, RESIN MOLDING AND COATING

Before bonding, molding or coating this product, verify that these processes do not affect the quality of capacitor by testing the performance of the bonded, molded or coated product in the intended equipment.

In case of the amount of applications, dryness / hardening conditions of adhesives and molding resins containing organic solvents (ethyl acetate, methyl ethyl ketone, toluene, etc.) are unsuitable, the outer coating resin of a capacitor is damaged by the organic solvents and it may result, worst case, in a short circuit.

The variation in thickness of adhesive, molding resin or coating may cause a outer coating resin cracking and/or ceramic element cracking of a capacitor in a temperature cycling.

8. OPERATING AND STORAGE ENVIRONMENT

The molding resin of the molding type ceramic capacitor does not form a perfect seal, avoid corrosive gas (e.g., hydrogen sulfide, sulfur dioxide, chlorine, ammonia gas etc.) and direct sunlight, and use (storage) in the condition without moisture condensation.

When washing, bonding or molding this product, make sure that there is no effect on the quality in your product. This one is MSL 3 product. So, in order to avoid the absorption of moisture, capacitors are moisture-proof package.

Under the following humidity and temperature conditions, the warranty period for unopened moisture-proof package is 2 years after the moisture-proof package is enclosed.

Solder the enclosed capacitors within 168 h after opening the moisture-proof package.

Also, even after opening, store it in the packing condition at the time of delivery or in a similar state.

Temperature : 10 to 30 °C

Humidity : 60 % max.

If it has been more than 1 week since opening, or if the HIC (humidity indicator card) indicates a level exceeding 10 %, perform baking (60 °C, 168 h) before mounting.

In addition, if it exceeds 12 months, check the solderability before use.

9. LIMITATION OF APPLICATIONS

The products listed in the specification (hereinafter the product(s) is called as the "Product(s)") are designed and manufactured for applications specified in the specification. (hereinafter called as the "Specific Application")

We shall not warrant anything in connection with the Products including fitness, performance, adequateness, safety, or quality, in the case of applications listed in from (1) to (11) written at the end of this precautions, which may generally require high performance, function, quality, management of production or safety.

Therefore, the Product shall be applied in compliance with the specific application.

WE DISCLAIM ANY LOSS AND DAMAGES ARISING FROM OR IN CONNECTION WITH THE PRODUCTS INCLUDING BUT NOT LIMITED TO THE CASE SUCH LOSS AND DAMAGES CAUSED BY THE UNEXPECTED ACCIDENT, IN EVENT THAT (i) THE PRODUCT IS APPLIED FOR THE PURPOSE WHICH IS NOT SPECIFIED AS THE SPECIFIC APPLICATION FOR THE PRODUCT, AND/OR (ii) THE PRODUCT IS APPLIED FOR ANY FOLLOWING APPLICATION PURPOSES FROM (1) TO (11) (EXCEPT THAT SUCH APPLICATION PURPOSE IS UNAMBIGUOUSLY SPECIFIED AS SPECIFIC APPLICATION FOR THE PRODUCT IN THE SPECIFICATION.*)

1. Aircraft equipment
2. Aerospace equipment
3. Undersea equipment
4. Power plant control equipment
5. Medical equipment
6. Transportation equipment
7. Traffic control equipment
8. Disaster prevention/security equipment
9. Industrial data-processing equipment
10. Combustion/explosion control equipment
11. Equipment with complexity and/or required reliability equivalent to the applications listed in the above.

For exploring information of the Products which will be compatible with the particular purpose other than those specified in the specification, please contact our sales offices, distribution agents, or trading companies with which you make a deal, or via our web contact form.

Contact form: <https://www.murata.com/contactform>

*We may design and manufacture particular Products for applications listed in (1) to (11). Provided that, in such case we shall unambiguously specify such Specific Application in the specification without any exception.

Therefore, any other documents and/or performances, whether exist or non-exist, shall not be deemed as the evidence to imply that we accept the applications listed in (1) to (11).

NOTICE**1. CLEANING (ULTRASONIC CLEANING)**

To perform ultrasonic cleaning, observe the following conditions.

Rinse bath capacity : Output of 20 watts per liter or less.

Rinsing time : 5 min maximum.

Do not vibrate the PCB/PWB directly.

Excessive ultrasonic cleaning may lead to fatigue destruction of the terminals.

2. CAPACITANCE CHANGE OF CAPACITORS

- Class 1 capacitors

Capacitance might change a little depending on a surrounding temperature or an applied voltage.

Please contact us if you use for the strict time constant circuit.

- Class 2 capacitors

Class 2 capacitors like temperature characteristic B, E and F have an aging characteristic, whereby the capacitor continually decreases its capacitance slightly if the capacitor leaves for a long time. Moreover, capacitance might change greatly depending on a surrounding temperature or an applied voltage. So, it is not likely to be able to use for the time constant circuit.

Please contact us if you need a detail information.

3. PERFORMANCE CHECK BY EQUIPMENT

Before using a capacitor, check that there is no problem in the equipment's performance and the specifications.

Generally speaking, Class 2 ceramic capacitors have voltage dependence characteristics and temperature dependence characteristics in capacitance. So, the capacitance value may change depending on the operating condition in a equipment. Therefore, be sure to confirm the apparatus performance of receiving influence in a capacitance value change of a capacitor, such as leakage current and noise suppression characteristic.

Moreover, check the surge-proof ability of a capacitor in the equipment, if needed, because the surge voltage may exceed specific value by the inductance of the circuit.

4. LAND DIMENSIONS

The recommendable land dimensions for reflow/flow soldering are follows.

Regarding the "a" dimension, to ensure the creepage distance required by the safety standard applies to your equipment.

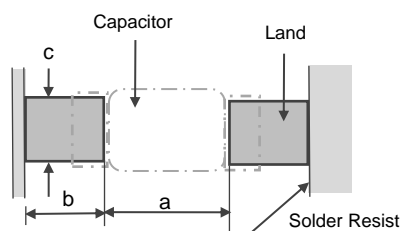

Dimension	a	b	c
8.0 × 6.0	8.0	2.2	3.6

⚠ NOTE

1. Please make sure that your product has been evaluated in view of your specifications with our product being mounted to your product.
2. You are requested not to use our product deviating from this specification.